



Roof Waterproofing Membrane Welding Machine

User's Guide for ZX7000



Roof waterproofing membrane welding machine is high quality automatic hot air welding machine; it is of new design and technology. ZX7000 is allowed to be sold before strict inspection.

Please read this manual carefully before using this machine, and retain it for future reference.

i. Applications:

It can be applicable for overlap welding PVC、TPO、ECB、CSPE、EPDM and other polymer film materials.

ii. Notice:

1. Unplug the tools before opening it to avoid of being hurt by exposed wires or component inside the machine with power
2. Incorrect use of it can cause fire and explosion hazard because of high temperature, especially near combustible materials and explosive gases.
3. Don't touch heater tube and nozzle when they are hot. They may cause burns. Don't point hot air flow in the direction of people or animals.
4. The voltage rating stated on the welder must correspond to line/mains voltage (220V).
The drop cable / wire with protective earthed conductors can only be used.
5. To ensure operator safety and reliable operation of equipment, the power supply must be installed power supply and leakage protection at the construction site.
6. It must be running at the correct use of manipulation of the operator, or they may cause a fire or explosion caused by high temperature.
7. Don't use welder in the water, or on a muddy construction site, to avoid flooding, rain or moisture.

iii. Technical Parameters:

Voltage	230	V
Frequency	50/60	Hz
power	4200	W
Temperature	50~620	°C
Welding speed	<7.8	m/min
Welding width	40	mm
Size(L*W*H)	555*358*300	mm
Weight	34	kg

iv. Description:

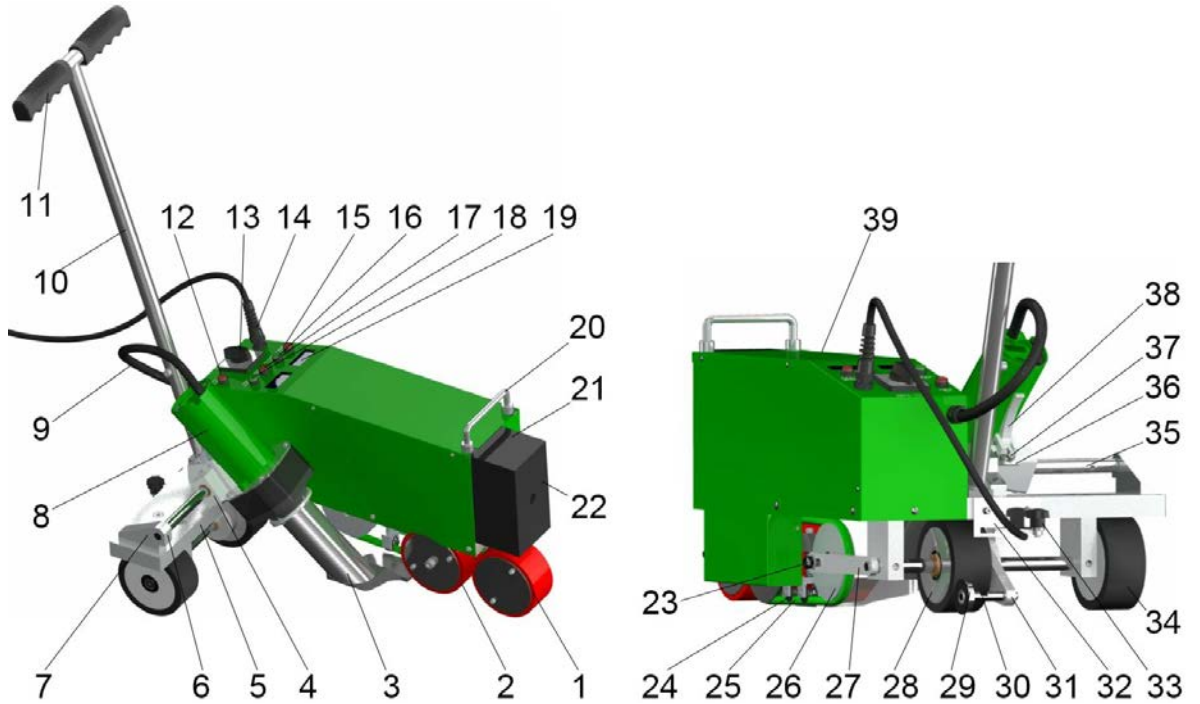

1.	Pressure roller	14	Power cord	27	Belt wheel linkage
2.	Drive roller	15	Temperature setting knob (—)	28	Front wheel (left)
3.	Hot air nozzle	16	Temperature setting knob (+)	29	Guide wheel
4.	Hot air blower fixed slider	17	Speed setting knob (—)	30	Fixed axle of guide wheel
5.	Machine frame	18	Speed setting knob (+)	31	fixed plate of guide wheel
6.	Hot air blower guide screw	19	LCD display screen	32	Limit groove plate of guide wheel
7.	Hot air blower fixed set	20	Lift handle	33	Handle of guide wheel
8.	Hot air blower	21	Clump weight (middle)	34	Front wheel (right)
9.	Power wire of hot air blower	22	Clump weight (outer)	35	guide rail of hot air blower
10.	Guide bar	23	Belt wheel fixed screw	36	Baffle of micro switch
11.	Handle	24	Rolling wheel	37	adjusting screw
12.	Moving switch	25	Round belt	38	Position handle of hot air blower
13.	ON/OFF switch	26	Belt wheel	39	Casing cover

v. Controller Panel

- ON/OFF switch (13) is used for open the main power of the welder
- Open ON/OFF switch (13), LCD display is shown as Figure 1, the hot air blower is under natural wind without heating.
- Press the button (15) and (16), the screen shows as Figure 2 and the hot air blower starts to heat until to the setting temperature.
- If press the bottoms (15) and (16) at the same time, LCD display shows as Figure 1, the hot air blower is under natural wind without heating.
- When the welding nozzle is at the right position, press the moving switch (12) and the welder starts to move and weld. It will stop move if you press the moving switch again.
- When the welder starts to move, the LCD display shows as Figure 3.

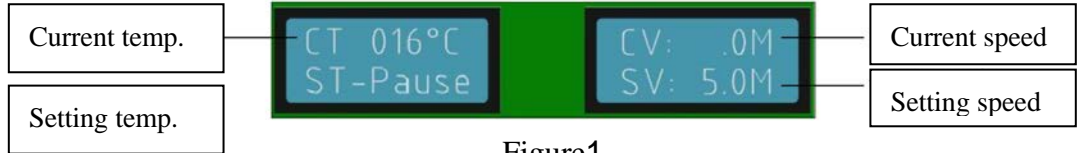
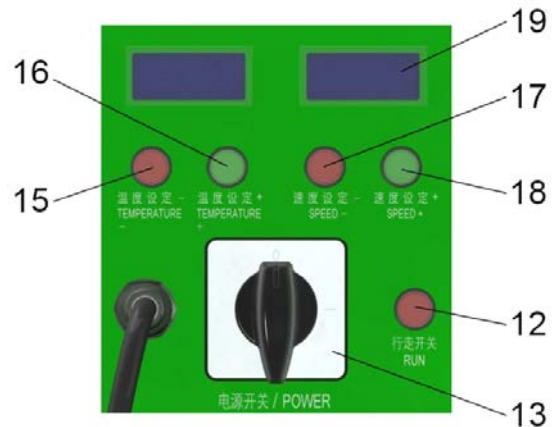

Figure 1

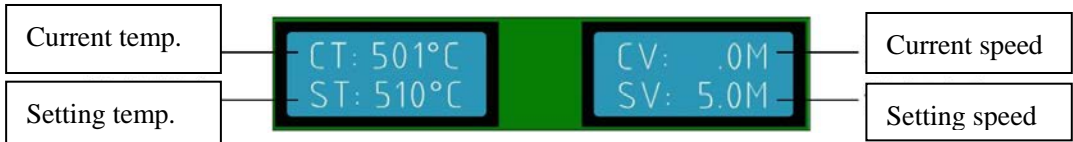



Figure 2



Figure 3



VI. Welding parameters setting

1. Welding temperature: :

Using bottoms Temperature setting knob+  and Temperature setting

knob-  on the panel to set the required temperature. You can set the temperature according to the welding materials and the ambient temperature. LCD display will show the set temperature and the current actual temperature.

2. Welding speed:

Using bottoms Speed setting knob+  and Speed setting knob -  on the panel to set the required speed according to the welding temperature. LCD display will show the set speed and the current actual speed.

3. The machine has a memory function parameters, namely when you use the welder next time, the welder will automatically use the last set of parameters without having to re-set parameters.

VII. Positioning the welder :

1. Depress handle (11) to lift machine, move it to welding position (the edge of upper film should keep in the same alignment with drive roller (2)), as shown in figure 4.
2. Lift guide bar (10) to make front wheel (left) (28) off the ground, slide handle of guide wheel (33) to right side until the right position of limit groove plate of guide wheel (32), to keep the guide wheel (29) in the same alignment with the edge of upper film.

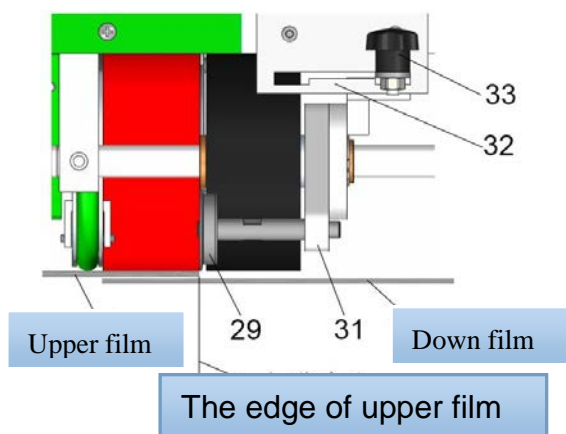

Figure 4

VII. Using Condition:

1. The distance between hot air nozzle and ground should be shown as figure 5. (We have adjusted the distance before leaving factory) .
2. The distance between hot air nozzle and drive roller should be shown as figure 6. (We have adjusted the distance before leaving factory) . You can adjust hot air nozzle adjusting screw (28) if the distance is not right.

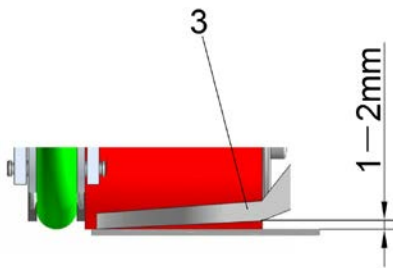

Figure 5

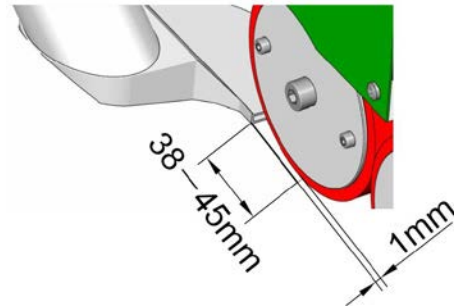

Figure 6

VIII. Welding process

1. Setting the welding parameters according to the data of welding test.
2. Please wait the actual temperature value reaching the setting value.
3. Positioning the welder
4. Lift the operating handle (38) to lower down the hot air nozzle (3) to close the down ground, to place hot air nozzle to left in the right position. The machine would start walking and welding automatically.
5. To observe the relative position of guide wheel (29). If it deviations from position, you can adjust it by flipping the handle (11)
6. When the welder walks into the end of material, pull up the position handle of hot air blower (38), move out of the hot air nozzle to right until stop, spin it up until lock.
7. After finish the welding job, press the Temperature setting knob+



and Temperature setting knob-

8. Last step is to off the power.



IX. Fault diagnosis and solved ways

The fault performance	Caused reasons	Solved ways
Welder cannot walk when hot air nozzle at the right place	Micro switch is not in right place	Move the hot air nozzle to the left and put it in place, then loosen adjusting screw (37); Move baffle of micro switch (36) , to place micro switch in the right position
The position between hot air nozzle and drive roller is not right		Adjust the fixed set of hot air blower (7) (by adjusting the screw under the fixed set of hot air blower)

X. Routine maintenance

Use steel brush to clean the hot air nozzle
Clean the air inlet at the back of the hot air blower

Company name: Zhengxi(Shanghai) Industrial Co.,Ltd.

Address:No.2185 Laifang Road,Songjiang Area,Shanghai,China

Tel : +86-21-2281.0889

Fax : +86-21-2281.6889

E-mail : info@ heatfounder.com

http:// www.heatfounder.com