



Shandong Sheenrun Optics & Electronics Co.,Ltd
Contact: Mary Tel:+86-13656408264 E-mail:tianhx@sheenrun.com www.sheenrun.com

SHR-MIR1000 Portable Multi-sensor Night Vision Camera



Main features

1. 25hz, 324x256,50mm thermal with high resolution Vox thermal sensor
- 2.Laser Range Finder
- 3.GPS function
4. 35mm day/light camera lens, magnification 6.5 x
- 5.Has Image Denoising and DDE functions, can output hot black/hot white/palette colors
6. Binocular OLED display
7. Analog video output, DC12V, built in lithium battery

Outline:



**Technical indicators**

Model	SHR-MIR1000		
Effective distance	Object	People (1.8m*0.5m)	Vehicle (2.3m*2.3m)
	Detect distance	1200m	3300m
	Recognize distance	300m	820m
Thermal imaging camera	Pixel	324×256	
	Spectral range	8-14μm	
	NETD	≤50mK (F1.0, 300K)	
	Focal length	50mm / F0.8	
	FOV	9.1 °x 7.3 °	
	Focus mode	Electronics	
Day light camera	Magnification	×6.5	
	FOV	7.8 °	
	Lens	35mm	
Image display	Display	OLED	
	Frame rate	25Hz	
GPS	Accuracy	10m(rms)	
	Satellite	GPS / Beidou-2	
Digital compass	Accuracy	±0.5 °(Dip angle 0 °)	
Laser range-finder	Laser type	Semiconductor laser, 1550nm laser wave length	
	Detection range	20m~2.5km (for 2.3m*2.3m size object)	
	Ranging accuracy	±2m (Within 1km), ±5m (1km -2.5km)	
Storage	Capacity	10000 pcs pictures; 30 hours video	
Interface	Power Supply	DC12V	
	Other interfaces	PAL video output, USB data interface	
Power	Voltage	DC12V	
	Last time	3 hours	
	Consumption	5W	
Environment indicators	Work Temp.	-20°C to +55°C	
	International protection	IP67	
Physical indicators	Weight	≤1.7kg	
	Size	223mm × 206mm × 82mm	

With Standard Configuration

No.	Component Name	Qty
1	MIR1000 handheld thermal camera	1
2	external cable	2
3	power adapter	1
4	lithium battery	2
5	BNC	2
6	lens cloth	1
7	carrying case	1



Dimension

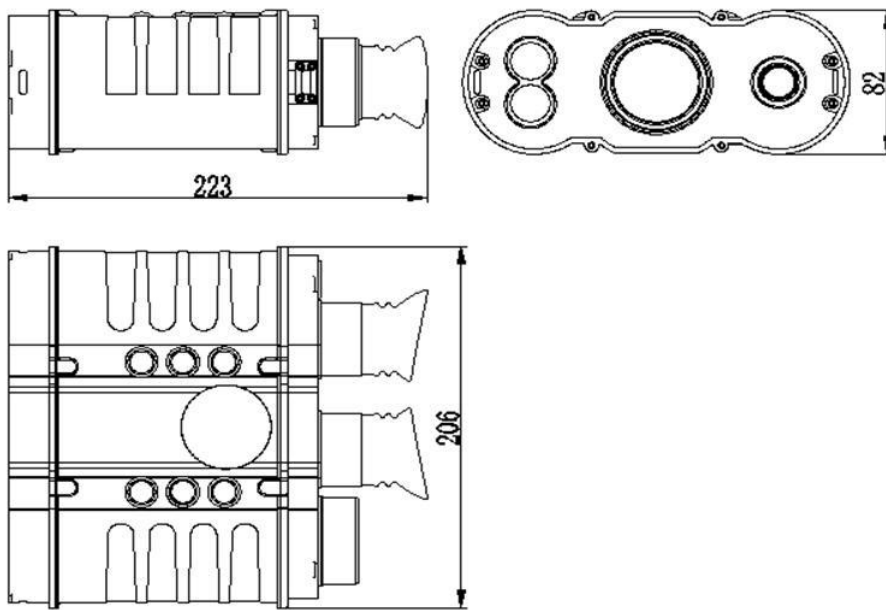

Size (mm)



Shandong Sheenrun Optics & Electronics Co.,Ltd

Contact: Mary Tel:+86-13656408264 E-mail:tianhx@sheenrun.com www.sheenrun.com

Image

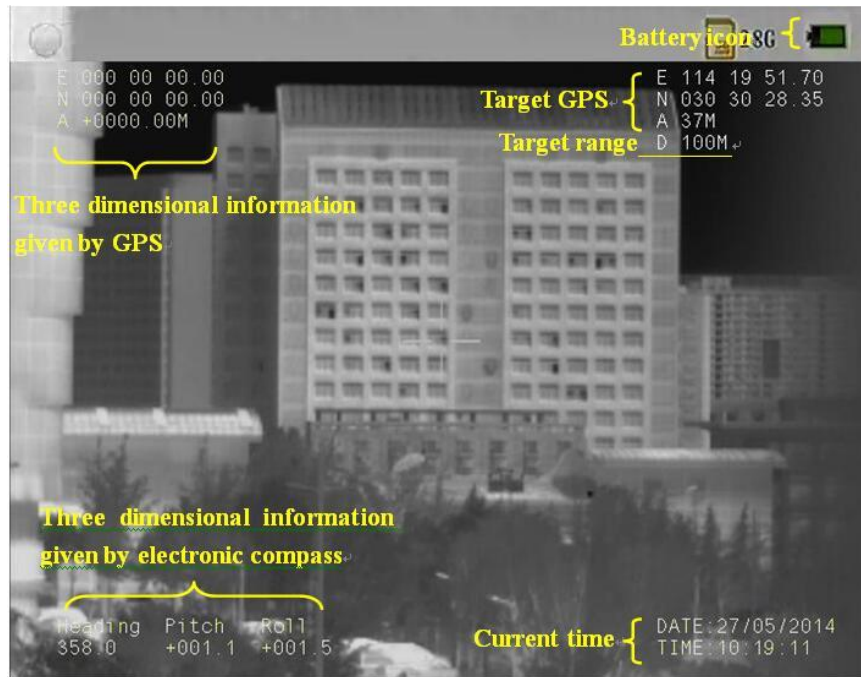

Exhibition photos

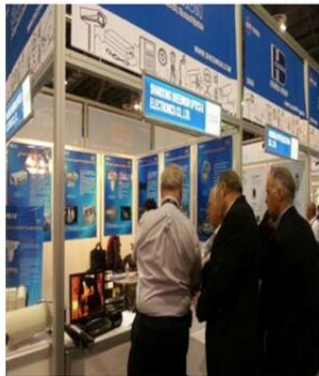

ISC West

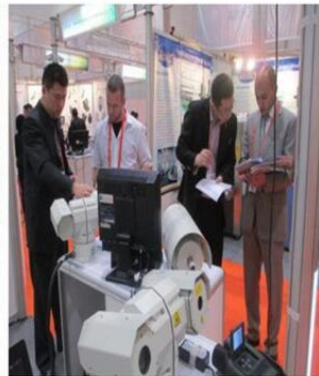

Intersec

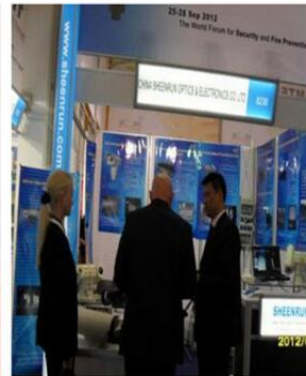

Security Essen

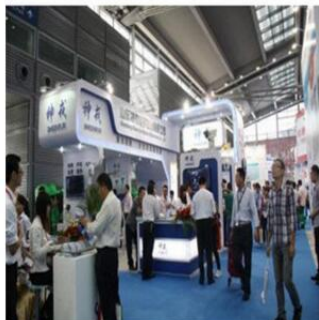

CPSE

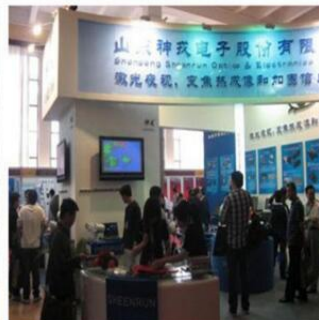

CIDEX

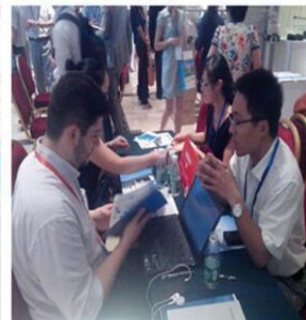

SSC

Our workshops



Our equipment



Delivery Time:

Quantity ≤ 10 set, it takes 15~25 days.

Quantity > 10 set, it takes 25~30 days with price discount

After Sales Service:

1. We offer one year warranty.
2. Email/ Skype/ Trade manager online to support.
3. Life-long technical support.
4. Professional technical team and salesperson help you with troubleshooting procedures via Internet and Phone any time when needed.
5. Engineers will be arranged to visit you if necessary.