

	POS.1	POS.2	POS.3
Model No.			
	ON	OFF	ON
Term. Comm.	2-3	OPEN	2-1
SCHEMATIC			

SWITCH FUNCTION

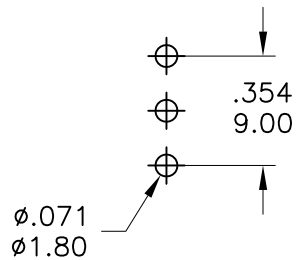

P.C. MOUNTING

SPECIFICATIONS

CONTACT RATING: AC 125V 6A, AC 250V 3A ,DC 30V 3A
MECHANICAL LIFE: 200,000 make-and-break cycles DC 10V & 0.1mA.
CONTACT RESISTANCE: 10mΩ max.
INSULATION RESISTANCE: 500V 500MΩ min.
DIELECTRIC STRENGTH: 1,000 V RMS@sea level.
OPERATING TEMPERATURE: -30°C to 85°C.
WATER-RESISTANCE: 100 make-and-break cycles MIN AT10cmDEPTH

MATERIALS

CASE: Dially phthalate (DAP) (UL94v-0).
ACTUATOR: Brass,chrome plated.
BUSHING: Brass,nickel plated.
HOUSING: Stainless Steel.
SWITCH SUPPORT: Brass,tin plated.
TERMINAL/CONTACT:Silver or gold plated.

RoHS Compliant

TOLERANCES ARE

MORETHANALL
 PCB CONNECTORS
 Cable ASSEMBLIES
 煜倫股份有限公司

DRAWING BY CY

CHECKED BY GENIUS

UNIT / mm

SCALE 1 : 1

DATE

SIZE A4

PPOJECTION

X. ±
 .X ± 0.40
 .XX ± 0.25
 .XXX ±
 ANG ± 5°



ORDER INFORMATION

TGSW45-DPB105-1X03-LF

SERIES

10.5mm

PANEL BACK

DIP 180°

03 WAY

LEADFREE

DESCRIPTION: Miniature Toggle Switches

www.morethanall.com

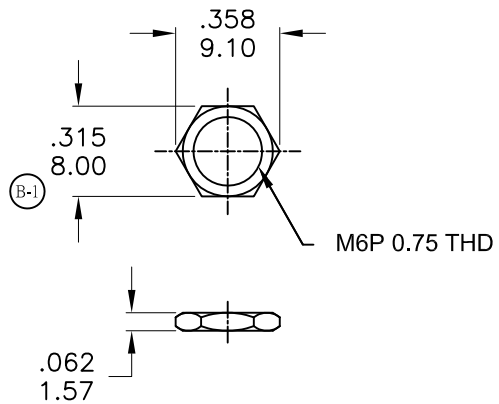

ø.425
ø10.80
(A)

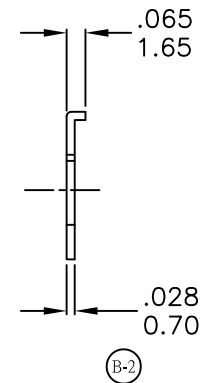
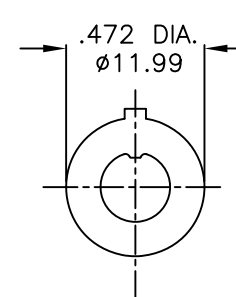
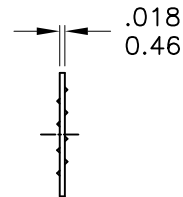
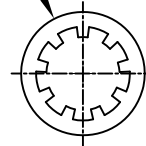

	PART NAME	Q'TY
1	METRIC NUTS(M6P 0.75 THD)	2
2	LOCKING WASHER	1
3	LOCKING RING	1

RoHS Compliant

TOLERANCES ARE

MORETHANALL
PCB CONNECTORS
Cable ASSEMBLIES

DRAWING BY CY

CHECKED BY GENIUS

UNIT / mm

SCALE 1 : 1

DATE

SIZE A4

PPOJECTION

X. ±
.X ± 0.40
.XX ± 0.25
.XXX ±
ANG ± 5°

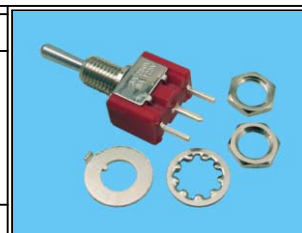

ORDER INFORMATION

TGSW45-DPB105-1X03-LF

SERIES

10.5mm

PANEL BACK

DIP 180°

03 WAY

LEADFREE

煜倫股份有限公司

www.morethanall.com

DESCRIPTION: M6P X 0.75 IN BUSHING PART