

GPSU15X-CC 15W Wall mount charger series

Plug-in power supply

Features:

- Universal input voltage
- Single output
- Pass LPS
- Optional output connectors
- Short circuit protection
- High efficiency & reliability
- Outputs are available at request
- Compact package
- One year limited warranty

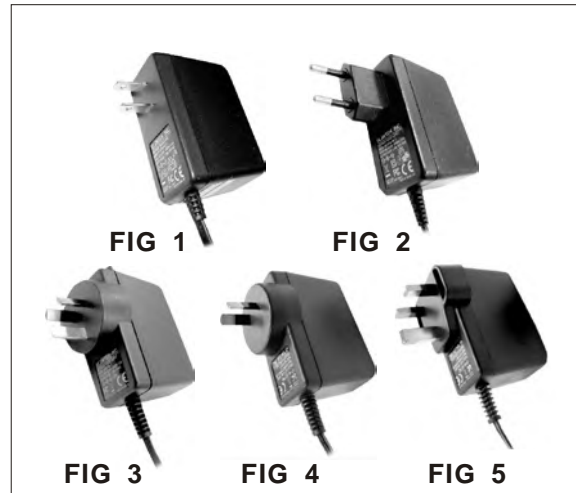

SAFETY AGENCY APPROVALS



Specifications:	GPSU15X-CC Series:
Input voltage	100 ~ 240 VAC
Input frequency	50 ~ 60Hz (Limits: 47 ~ 63 Hz)
Input current	0.5A Max.
Safety ground leakage current	0.25mA Max. @ 240 VAC / 50Hz
Output voltage	See rating chart
Output current	See rating chart
Output power range	See rating chart
Ripple	1% peak to peak maximum. See rating Chart
Over voltage protection	Yes, Protected by Zener diode
Over current protection	Yes. Auto - recovery. Standard Series : Rated output current > 110% for primary-referenced direct drive (Constant current series : Rated output current 80~200% for secondary-referenced direct drive)
Short circuit protection	Yes. Hiccup mode; Auto-recovery
Temperature coefficient	All output $\pm 0.04\%/^{\circ}\text{C}$ maximum
Transient response	Maximum excursion of 4% or better on all models. Recovering to 1% of final value within 500uS after a 25% step load change
Operating temperature	0°C~+40°C. See derating curve
Storage temperature	-40°C~+85°C
Relative humidity	5% to 95% non-condensing
Derating	Derated from 100% at +40°C linearly to 70% at 50°C
Efficiency	See rating chart
Setup up / Hold up / Rise time	Typical : 3000mS / 16mS / 50mS at full load.
Line regulation	$\pm 1\%$ maximum for any input voltage change between input voltage range
Load regulation	Typical $\pm 5\%$ variations from minimum to maximum output current . Or see rating chart
Insulation resistance	50 Mohm minimum from input to ground
Inrush current	20 AMPS @ 115 VAC ; 40 AMPS @ 230 VAC at 25°C cold start
Withstand voltage	4242VDC from input to output
Mean time between failure	100,000 hours minimum at full load at 25°C ambient
EMI requirements	(A)CE : Emission : EN55022 ; EN61000-3-2,3 / Immunity: IEC61000-4-2,3,4,5,6,11 (B)FCC 47 CFR Part 15 Subpart B. ICES-003 Issue 4 ANSI C63.4-2003
Safety requirements	(A) UL60950-1 ; CSA C22.2 (B)EN60950-1 ; IEC60950-1
Warranty	1 year

GPSU15X-CC 15W Wall mount charger series

UNIT: mm

FIG 1 (UL)

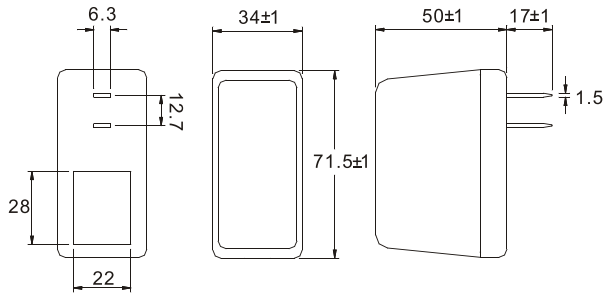

FIG 2 (TUV)

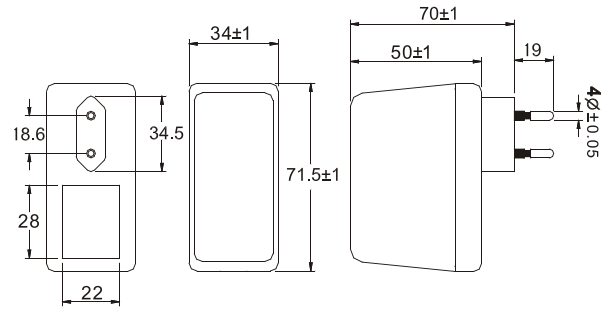

FIG 3 (S)

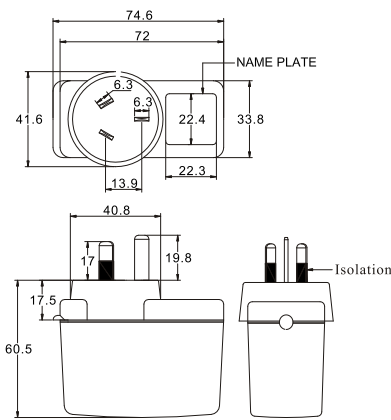

FIG 4 (SA)

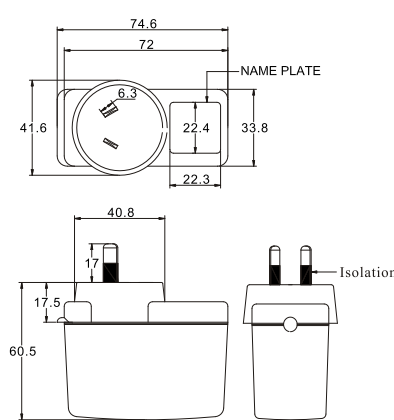
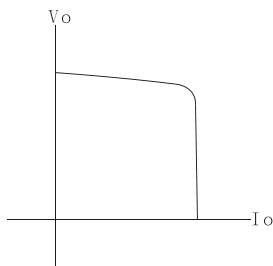
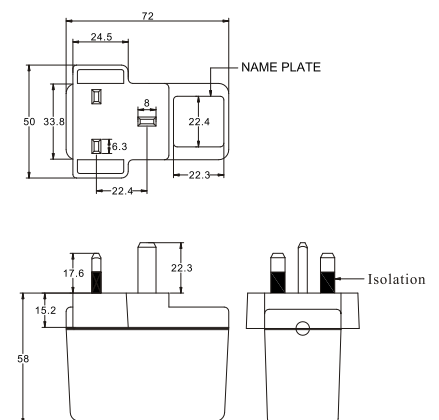
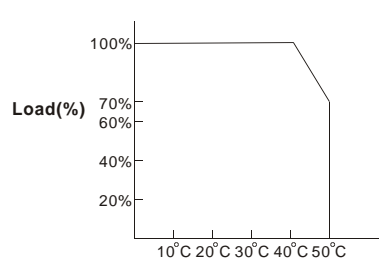

FIG 5 (UK)



CONSTANT CURRENT CURVE



Ambient temperature(°c)
Derating

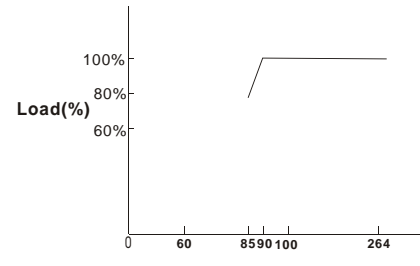

Input Voltage(VAC)
Typical static characteristics

X= U American type (FIG1) or E European type (FIG 2)

X=S 3pin Australian type (FIG3) or SA 2pin Australian type (FIG4) or BS UK type (FIG5)

Model name	Output Voltage(VDC)	Output Current(A)	Max.Output power(W)	Ripple.(mV) max.	Line Regulation(%)	Load Regulation(%)	Eff.(%)	No load Power Consumption(W)	Measured at the output of
GPSU15X-0-CC	3~5	2.40~1.44	7.2	50	±1	±10	55	<0.5	4.2
GPSU15X-1-CC	5~6	2.40~2.00	12	50	±0.5	±10	65	<0.5	5.6
GPSU15X-1-1-CC	6~8	2.00~1.50	12	80	±0.5	±5	74	<0.5	7.2
GPSU15X-2-CC	8~11	1.80~1.36	15	80	±0.5	±5	76	<0.5	8.4
GPSU15X-3-CC	11~13	1.36~1.15	15	100	±0.5	±5	76	<0.5	12
GPSU15X-4-CC	13~16	1.15~0.94	15	120	±0.5	±3	76	<0.5	13.8
GPSU15X-5-CC	16~21	0.94~0.72	15	120	±0.5	±3	77	<0.5	18
GPSU15X-6-CC	21~27	0.72~0.55	15	150	±0.5	±3	78	<0.5	24
GPSU15X-7-CC	27~33	0.55~0.45	15	240	±0.5	±2	80	<0.5	30
GPSU15X-8-CC	33~48	0.45~0.31	15	240	±0.5	±2	80	<0.5	48

Note:

- 1.Weight:Approx 70~150g
- 2.Optional output connectors(see page 72)