

2.00ø Wire to Wire Power Connectors

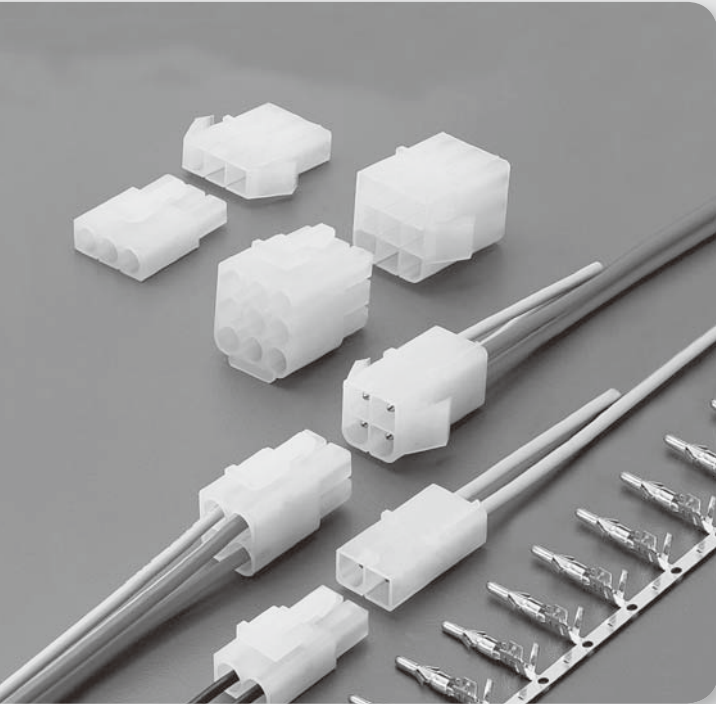

Specifications

- Voltage Rating : 300 - 600V AC/DC
- Current Rating : 9 - 15A AC/DC
- Withstanding Voltage : 1,500V AC/minute
- Insulation Resistance : 1,000MΩ min.
- Temperature Range : -25°C to + 85°C
- Contact Resistance : 20mΩ max.

Features:

■ HOUSING

Part No. : JS-2000H

JS-2000H-xxE

JS-2000W

Poles : 1,2,3,4,6,9,12,15

Material : Nylon 66 UL94V-2

Q,ty : 1,000 pcs/Bag

■ TERMINAL

Part No. :

JS-2000H-TH, JS-2000W-TH (AWG# 14 - 18)

JS-2000H-TL, JS-2000W-TL (AWG# 18 - 22)

Material : Brass

Finish : Tin Plated

Thickness : 0.25mm

Q'ty :

JS-2000H-TH, JS-2000W-TH - 3,500 pcs/Reel

JS-2000H-TL, JS-2000W-TL - 5,000 pcs/Reel

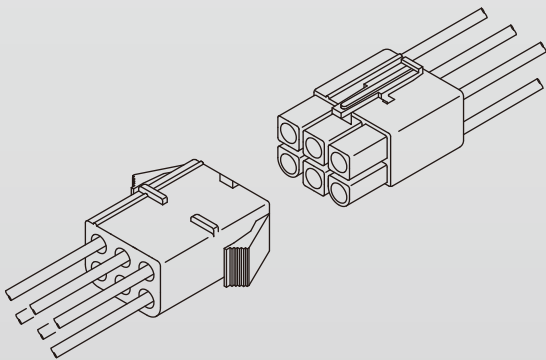

2.00ø Wire to Wire Power Connectors

Terminal

JS-2000H-TH / TL

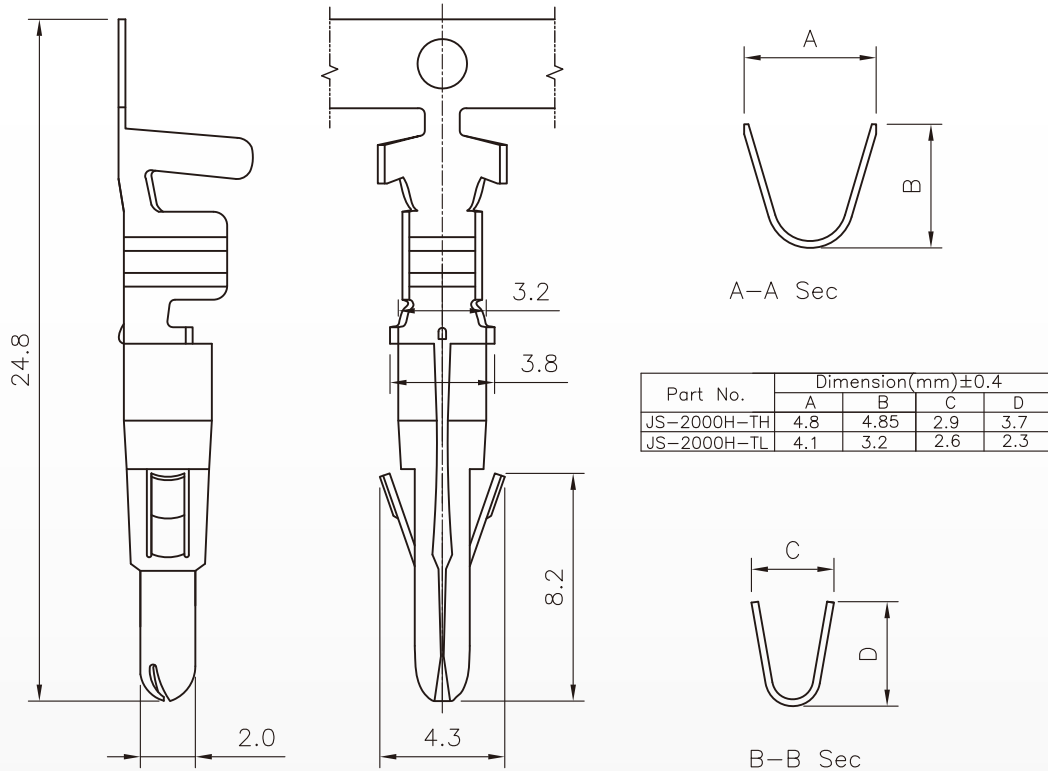

Terminal

JS-2000W-TH / TL

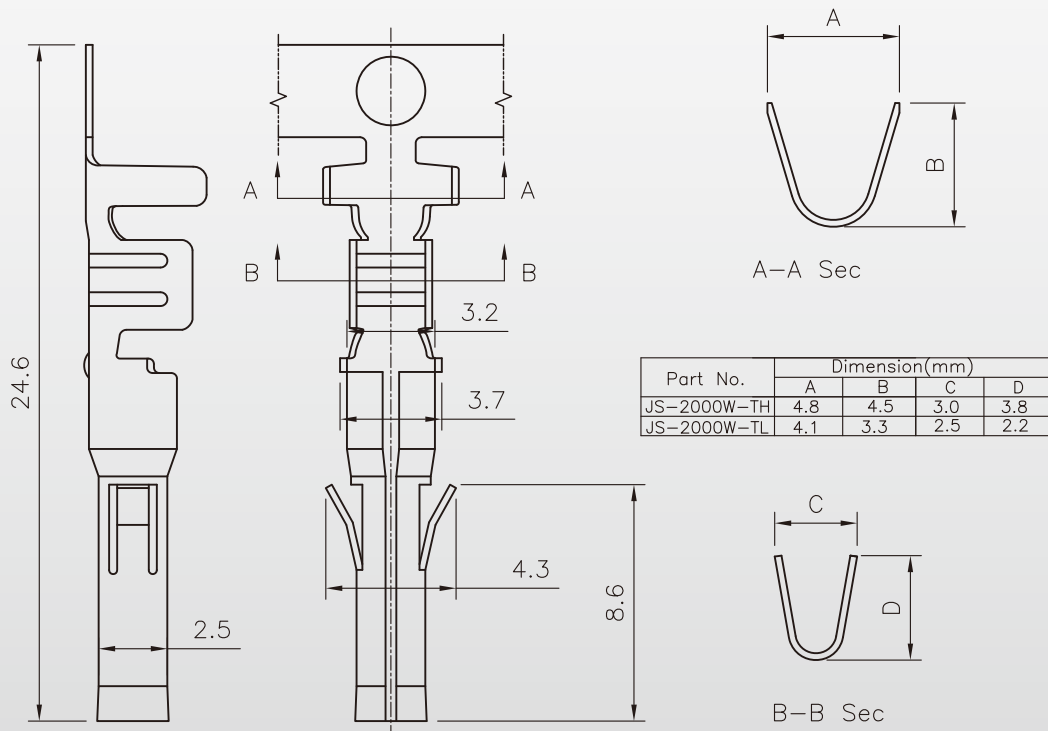

2.00ø Wire to Wire Power Connectors

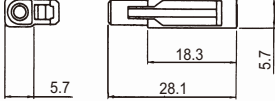
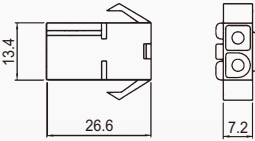
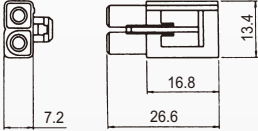
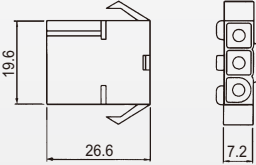
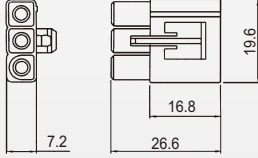
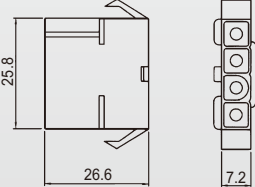
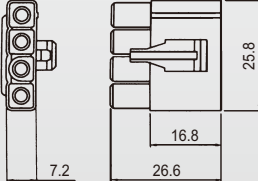
Poles	Max. Rated		Dimension Information	
	Amps	Voltage	Receptacle W/O Mfg. ears or W/Mfg. ears	Plug
1	15A	600V	<p>JS-2000H-01</p> 	<p>JS-2000W-01</p> 
2	15A	300V	<p>JS-2000H-02 \ JS-2000H-02E</p> 	<p>JS2000W-02</p> 
3	14A	300V	<p>JS-2000H-03E</p> 	<p>JS-2000W-03</p> 
4	13A	300V	<p>JS-2000H-04E</p> 	<p>JS-2000W-04</p> 

2.00ø Wire to Wire Power Connectors

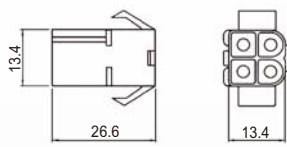
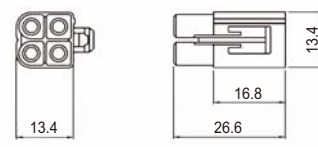
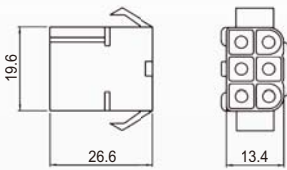
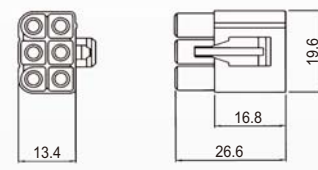
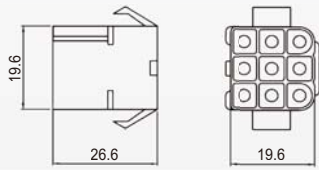
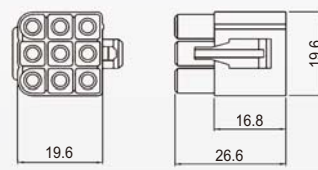
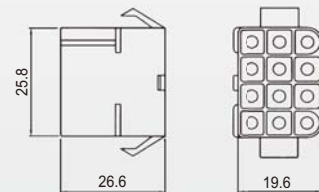
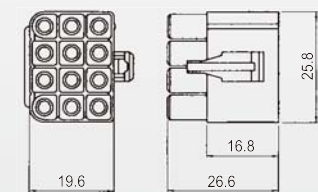
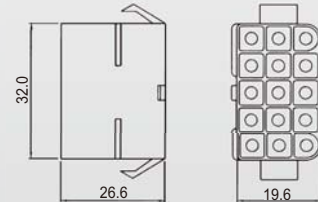
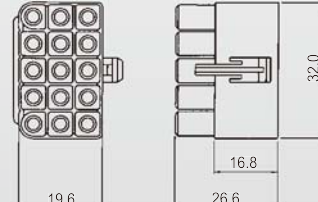
Poles	Max. Rated		Dimension Information	
	Amps	Voltage	Receptacle W/Mfg. ears	Plug
4	13A	300V	JS-2000H-2X2E 	JS-2000W-2X2 
6	12A	300V	JS-2000H-2X3E 	JS2000W-2X3 
9	10A	300V	JS-2000H-3X3E 	JS-2000W-3X3 
12	9A	300V	JS-2000H-3X4E 	JS-2000W-3X4 
15	9A	300V	JS-2000H-3X5E 	JS-2000W-3X5 

C