

Quality Goods Are Trustworthy

ours

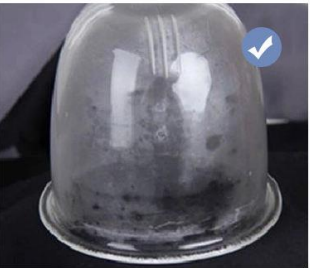

comfort skin-friendly soft



more breathable fabric

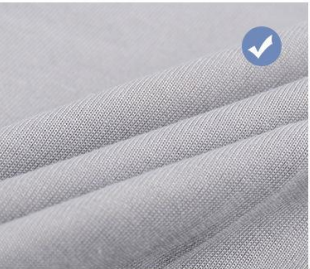

anti-pilling



smooth and meticulous workmanship

others



itchy uncomfortable easy pilling



hot and airtight

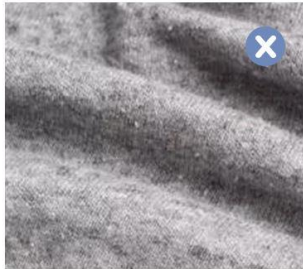

easy pilling

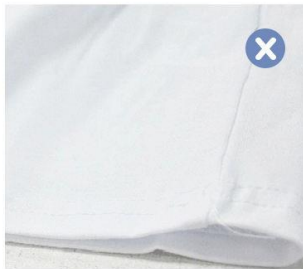

rough workmanship

About color difference



It shows color in difference browser

LED monitor

Laptop monitor

Flat screen display



DICASA Browser



Meitu



WIN7

*Different monitors will have a little color deviation



Unisex tracksuits



Case Presentation



Our Satisfied Clients



The hoodie are amazing, you guys did a good custom job.

The material was great, and the printing was done very professional! I loved the service so much.



I ordered 2000 pieces early and they all sold out in 2 weeks.

Products	T shirt ,Polo Shirt,Hoodie(Sweatshirt),Pants(Jogger) Work Clothes,Technical Jacket,etc
Logo	Can be customized
Sexuality&Age	Men/Women/Junior/Youth/Toddler/Newborn/Enfant
Fabric	Cotton(100% cotton),Long-staple Cotton (85% cotton+15% polyester), Model(95% model+5% spandex),Combed Cotton(100% cotton), Polyester(100% polyester) , Mercerized Cotton(100% cotton), PIQUE(65% polyester+35% cotton),Tencel cotton (65% cotton +35% tencel), Lycra(90% cotton+10% spandex),Siro Cotton(65% polyester +35% cotton), AB Cotton(50% polyester+50% cotton).etc
Feature	Eco-Friendly,anti-shrink,Anti-Pilling,Breathable,Comfortable,Quick Dry,Plus size, Thermal,Recycle ,Yarn-Dyed,Moisture Wicking,etc
Suitable Occasion	Casual/Office/Social Contact/Hip Hop/High Street/Punk Style/Moto&Biker/ Preppy Style/England Style/Harajuku/Vintage/Normcore etc
Neck	O-neck,crew neck,Turn-down collar,stand collar,V neck,Polo neck,Turtleneck,etc
Sleeve	Short sleeve,long sleeve,Half sleeve,3/4sleeve,sleeveless,etc
Size	XXXS,XXS,XS,S,M,L,XL,2XL,3XL,4XL,5XL etc.Size can be customized for bulk production
Color	White,black, gray,red,blue,yellow,green,navy,pink,khaki etc
Weight	140g,160g,180g,200g,220g,240g,260g,280g,300g,400g etc
Craftworks	Hot sizing process/Heat transfer print/Embroidery/Screen printing All-over printing/Gold(Silver)ironing process/bead
Sample time	For our in-stock items: 1~3 days for blank shirts 2~5 days for orders of Heat Transfer Print/Hot Sizing Process/Gold,Silver Ironing Process 3~7 days for orders of Embroidery/Screen Printing/All Over Printing(AOP) For sizes or colors or fabric customed Clothes: It depends(usually 5~15 days).For more information,please contact us

Product Size

REF	POSITION	S	M	L	XL	2XL	3XL	To+/-
A	Body length from side neck point	68	70	72	74	76	78	1cm
B	Neck width:seam to seam	20	20.5	21	22	22	22.5	0.5cm
C	Chest at armhole	58	60	62.5	65	67.5	70	1cm
D	Relaxed rib bottom width	46	48	50	53	55	57.5	1cm
E	Hem width before rib attachment	53	55.5	58	61	63	65.5	1cm
F	Sleeve length from c.back/cerv.	86	88	90	92	94	96	1cm
G	Armhole drop from SNP	28	29	30	31	32	33	0.5cm
H	Sleeve width 25cm up from cuff sear	17	17.5	18	19	19	19.5	0.5cm
I	Rib cuff opening	8.5	9	9	9.5	9.5	9.5	0.5cm
J	Half hood opening length	38	38	38	38	38	38	0.5cm
K	Half hood at widest point	26	26	26	26	26	26	0.5cm

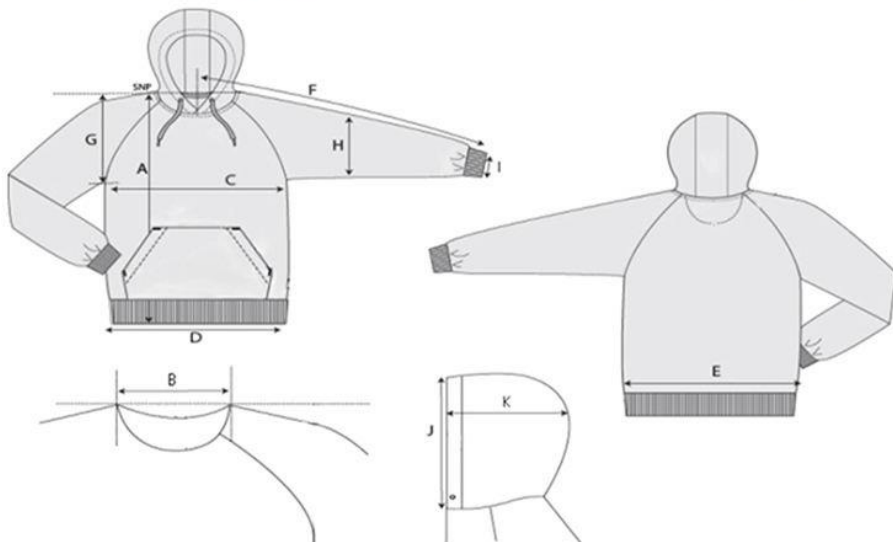

Custom Services

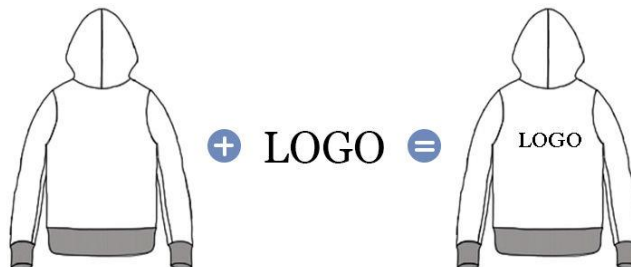
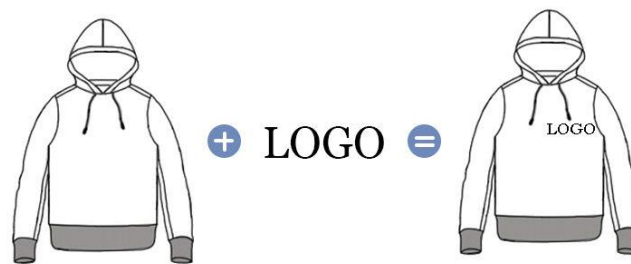

PRINTING & EMBROIDERY LAYOUT OPTIONS

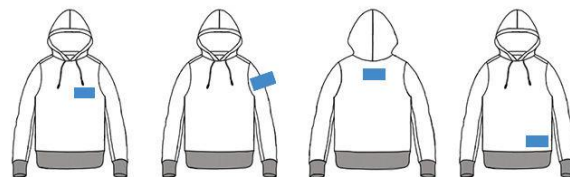

A:Left chest B:Sleeves C:Neckline D:Hem

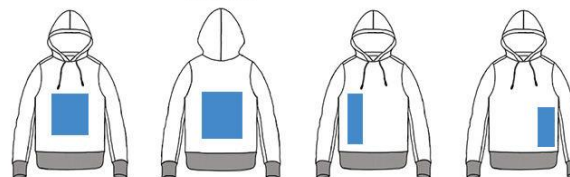

E:Front chest F:Back G:Side seam H:Whole body

Cost extra USDo.3 for options of A/B/C/D

Cost extra USDo.4 for options of E/F/G/H

*Printings combine are available,
freely to contact us for more customization options

