

A-STAR SERIES

LED High Bay

80W-240W

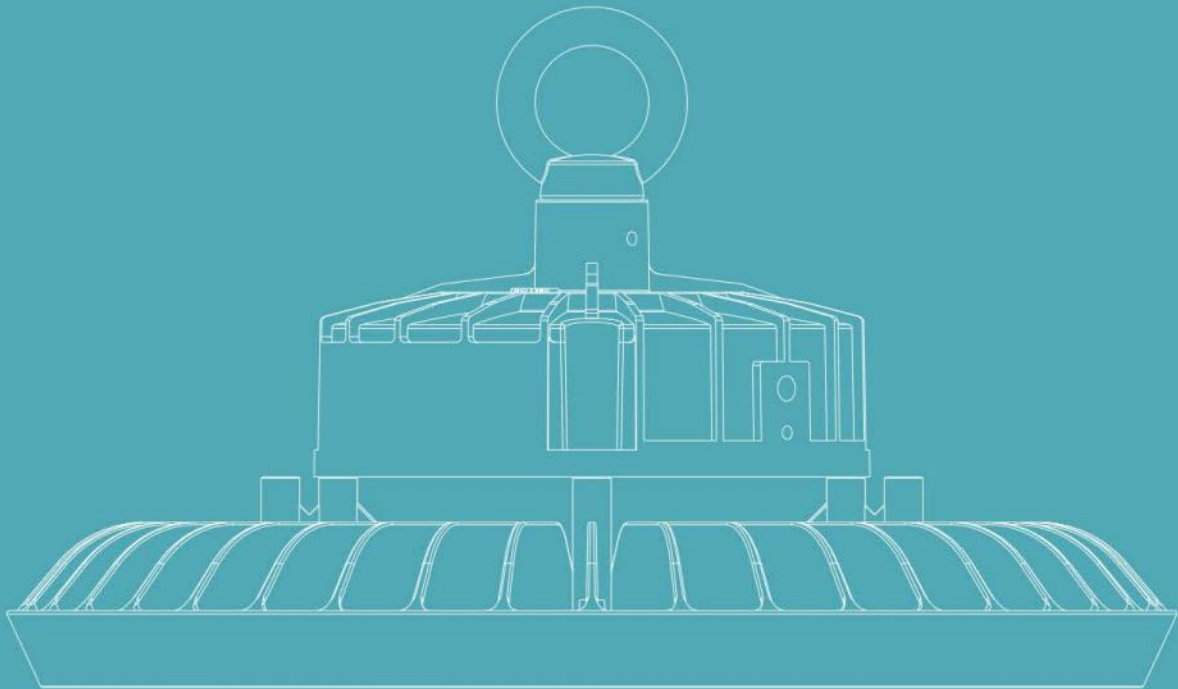



1.Features:

- ◆ Die casting aluminum housing.
- ◆ Perfectly suitable for logistical centers, warehouses.
- ◆ Beam angle optional: 60°; 90°; 120°
- ◆ Brand LED driver and LED components
- ◆ Easy to install, fast replacement.

2.Application:



Ideal for Warehouse, Workshop, Garage, Stadium, Gas station, Supermarket, Hall and other indoor public/private places.

3.Product Dimension

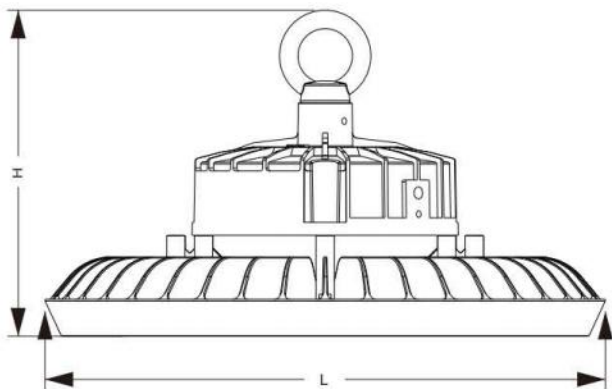

| Model | Dimensions: L * H (unit mm) |
|-------------|-----------------------------|
| MS-SP247080 | 275*275*166mm |
| MS-SP248100 | 275*275*166mm |
| MS-SP249120 | 285*285*168mm |
| MS-SP250150 | 285*285*168mm |
| MS-SP251200 | 305*305*177mm |
| MS-SP252200 | 360*360*183mm |
| MS-SP253240 | 360*360*183mm |

4. Light distribution curve

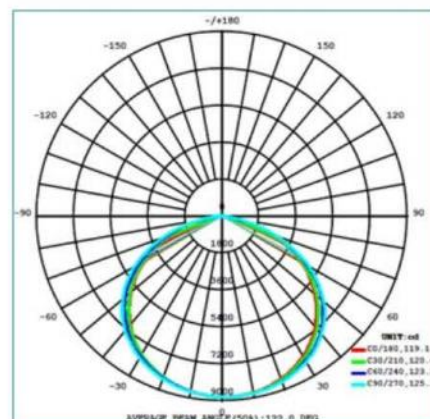
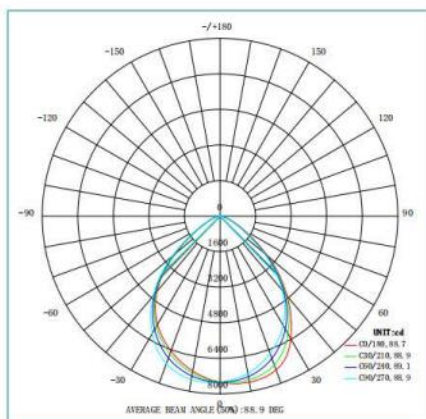
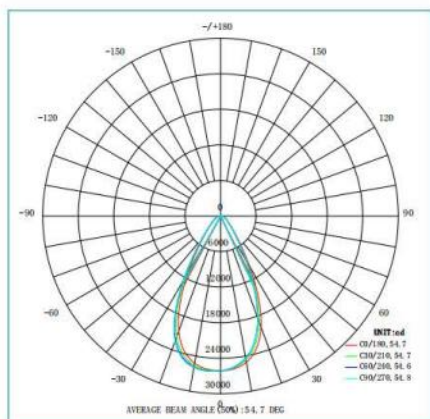

5. Technical parameters

| Model | MS-SP247080 | MS-SP248100 | MS-SP249120 | MS-SP250150 | MS-SP251200 | MS-SP252200 | MS-SP253240 |
|--------------------------|------------------------------|-------------|---------------|-------------|---------------|---------------|-------------|
| Input voltage | 120-277V | | | | | | |
| Power efficiency | >90% | >90% | >92% | >92% | >93% | >93% | >93% |
| Power factor | >0.95 | | | | | | |
| System power consumption | 80W | 100W | 120W | 150W | 200W | 200W | 240W |
| Luminous flux | 10400LM | 13000LM | 15600LM | 19500LM | 26000LM | 28600LM | 31200LM |
| Spot type | 60,90,120 | | | | | | |
| Luminous efficiency | 130LM/W (160 lm/W available) | | | | | | |
| Color temperature | 3000-6500K | | | | | | |
| Color rendering index | >75 | | | | | | |
| IP | IP65 | | | | | | |
| Certification | CE | | | | | | |
| Life Span | >50000/h | | | | | | |
| Net weight | 2.8KG | | 3.2KG | | 3.6KG | 4.2KG | 4.5KG |
| Product dimensions | 275*275*166mm | | 285*285*168mm | | 305*305*177mm | 360*360*183mm | |
| Package Size | 360*360*155mm | | 360*360*155mm | | 375*375*175mm | 430*430*175mm | |

IP65
CRI 70/80
100-240V 120-277V
47-63Hz
PF >0.95
20-95%RH
CCT 3000K / 4000K 5000K
CCT 5700K 6500K
50000h

6.Installation

LED HIGH BAY LIGHT

Installation instruction



| Model | L(mm) | H(mm) | Rated Voltage | Frequency |
|-------------|-------|-------|-----------------------------------|-----------|
| MS-SP247080 | Φ275 | 166 | please refer to the product label | |
| MS-SP248100 | Φ275 | 166 | | |
| MS-SP249120 | Φ285 | 168 | | |
| MS-SP250150 | Φ285 | 168 | | |
| MS-SP251200 | Φ305 | 177 | | |
| MS-SP252200 | Φ360 | 183 | | |
| MS-SP253240 | Φ360 | 183 | | |

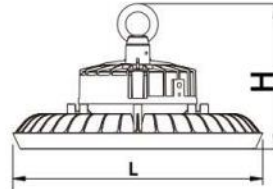

Ring installation

01

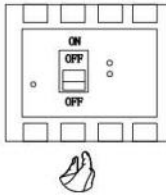

Cut off the power

02

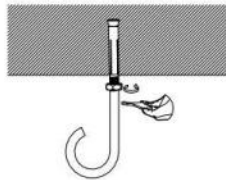

Nail the expansionscrew(hook shape)onto the ceiling

03

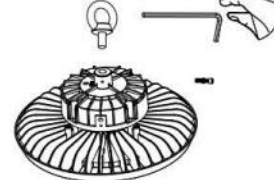

Fit the reflector on the POD fixture,and fasten it tightly!

04

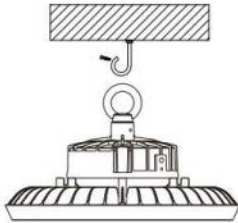

Hang the fixture on the Hook and fasten it tightly by screw!

05

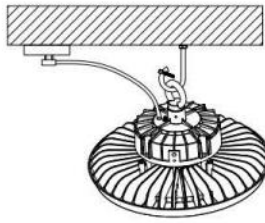

Insert the plug into socket

06

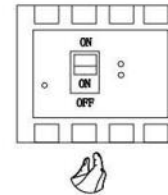

Turn on the Power

Chain installation

01

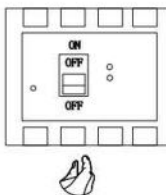

Cut off the power

02



Nail the expansionscrew(hook shape)onto the ceiling

03



Fit the reflector on the POD fixture,and fasten it tightly!

04



Hang the fixture on the Hook and fasten it tightly by screw!

05



Insert the plug into socket

06

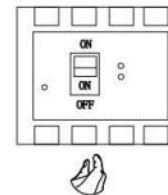

Turn on the Power

6.Installation

| | | | | | | | |
|----------------------|-------------------|--|-------------------|---|---|---|---|
| Bracket Installation | 01 | | 02 | | 03 | | |
| | | Cut off the power | | Nail the expansionscrew(hook shape)onto the ceiling | | Fit the reflector on the POD fixture,and fasten it tightly! | |
| | 04 | | 05 | | 06 | | |
| | | Hang the fixture on the Hook and fasten it tightly by screw! | | Insert the plug into socket | | Turn on the Power | |
| | Boom Installation | 01 | | 02 | | 03 | |
| | | | Cut off the power | | Nail the expansionscrew(hook shape)onto the ceiling | | Fit the reflector on the POD fixture,and fasten it tightly! |
| 04 | | | 05 | | 06 | | |
| | | Hang the fixture on the Hook and fasten it tightly by screw! | | Insert the plug into socket | | Turn on the Power | |

Optional aluminum lampshade

Announcements:

1. Please check the wire is broken before connecting the wire
2. Please check if you shut the power before connecting
3. Please connect the wire with right color show in the sketch map
4. After connected to the power cable,make sure the cable joint position and wire of lamp must be waterproof processing,IP≥65
5. It's normal phenomenon,there is temperature rise on the products surface when use.
6. Please kindly read the introduction carefully to avoid the accident and damage. Just can be repaired and cleared after cutting off power.
7. Must be installed by qualified electrician. The connection way must be suitable for IEE electrical standard or national standard.
8. Please kindly use soft cloth to clear it regularly (annually) to maintain the brightness.
9. It should be stocked in the shady, dry and clear environment and the stocked temperature is -40℃ to 50℃ (Note:MS-SP251200 Ta @40℃).



| Model | Single Box | N.W.(kg) | Meas(mm) |
|-------------|------------|----------|---------------|
| MS-SP247080 | 1 | 2.8 | 360*360*155mm |
| MS-SP248100 | 1 | 2.8 | 360*360*155mm |
| MS-SP249120 | 1 | 3.2 | 360*360*155mm |
| MS-SP250150 | 1 | 3.2 | 360*360*155mm |
| MS-SP251200 | 1 | 3.6 | 375*375*175mm |
| MS-SP252200 | 1 | 4.2 | 430*430*175mm |
| MS-SP253240 | 1 | 4.5 | 430*430*175mm |

7. Matters needing attention:

- ◆ Pls read the instruction manual carefully before installing the lighting fixtures.
- ◆ The disassembling and installation work are not allowed by the Non-professional.
- ◆ Please check the local voltage in accordance with the product requirements before using the products.
- ◆ Before connecting the power, pls ensure the that the switch is off to get rid of any electric shock.
- ◆ When using , do not put the item into any enclosure as it may affect the heat dissipation when working.
- ◆ Misuse of, or changes to the fixture shall nullify the guarantee.
- ◆ Make the power off and let it cool down completely when cleaning the led fixtures.
- ◆ Pls check the product carefully before installation, if any damage, pls keep it in the same and good packing and advise us in a timely manner.