



Tuya Smart



Smart Life

## 1080P IP Video Doorbell

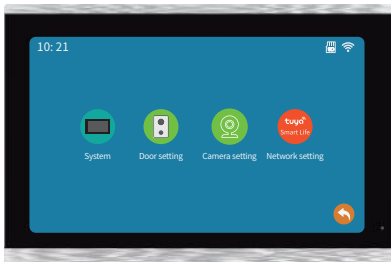
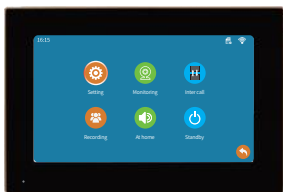

Touch



Full HD



Night Vision



Full duplex



Multi user



Take photo



Unlock



WiFi



140 Angle



Wakeup Anytime



Motion Detect



Cloud



Take video













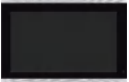

Playback

# 1 Function

<b>Resolution</b>	2Mega pixels, 140 Horizontal angle
<b>Night vision</b>	IR CUT no color deviation, B/W night vision
<b>Unlock</b>	Power on or off unlock, unlock delay time setting by indoor monitor
<b>Monitor</b>	7inch or 10.1inch capacitive touch 1024*600 indoor monitor
<b>Connect</b>	Connect up to 4 outdoor doorbells and 6 indoor monitors, the indoor monitors can talk to each other
<b>Network</b>	Master indoor monitor connects 2.4G WiFi 802.11 b/g/n
<b>Function</b>	Take photo, take video, unlock, lock delay, motion detection calendar, adjust brightness, contrast, color
<b>TF Card</b>	External TF card to save photos or videos, leave messages
<b>Tuya smart or Smart Life APP</b>	20 App users can connect to the system, users can talk to visitors anytime and anywhere, and take photo or video, monitor, unlock
<b>Message</b>	Push photo to APP when motion detection or call
<b>Playback</b>	Video recording after the call or motion detection

# 2 Packing list

<p>1</p>  <p>Outdoor doorbell</p>	<p>2</p>  <p>Unlock cable</p>	<p>3</p>  <p>Hex screwdriver</p>	<p>4</p>  <p>Screws and rubber plugs</p>	
<p>5</p>  <p>Cat5E/Cat6/ Cat6A cable</p>	<p>Optional</p>  <p>1* Yellow Add card 1* Red Delete card 5* Blue User cards Unlock control Remote control POE injector</p>			
<p>1</p>  <p>7 or 10.1 inch indoor monitor</p>	<p>2</p>  <p>Hanging plate</p> <p>3</p>  <p>KA4*25 Screw</p>	<p>4</p>  <p>RJ45 converter</p>	<p>5</p>  <p>12V 2A power supply</p>	<p>6</p>  <p>DC cable</p>

### 3 Specification

#### Model 1 of outdoor doorbell

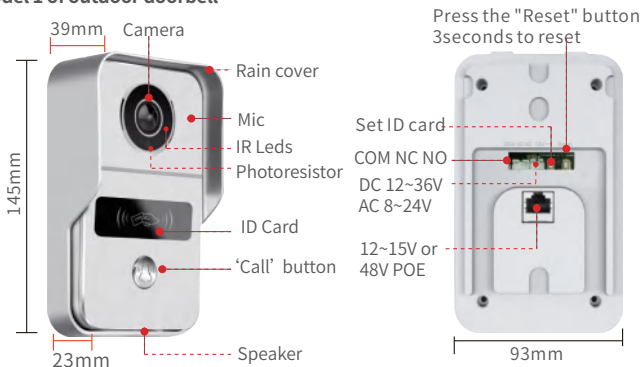

#### Model 2 of outdoor doorbell

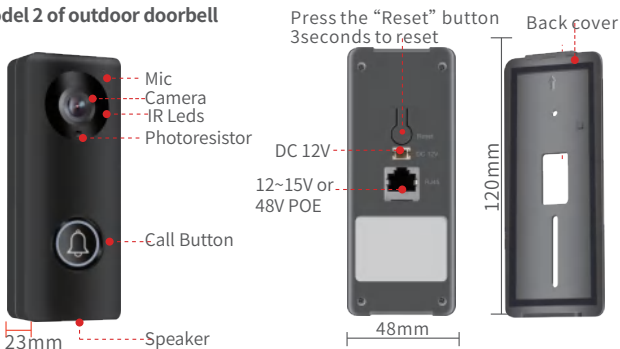

#### 10.1 inch indoor monitor

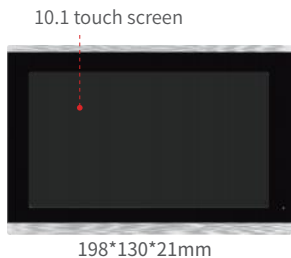

#### 7 inch indoor monitor

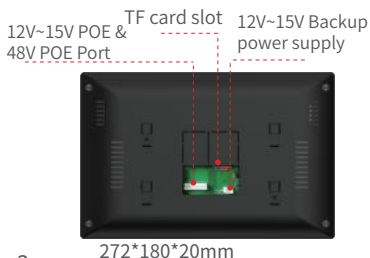

## 4 Installation diagram

The outdoor doorbell is installed at a height of 1.4~1.7 meters, try to avoid the sunshine and rain, Using 2 screws or tape fixed the outdoor doorbell on the wall, wooden board, door, It can also be installed on the 86 box.

1. Use the drill bit to drill three holes. One hole is large enough to pass through the Cat5e cable, use anchors if user install outdoor doorbell on brick or concrete.

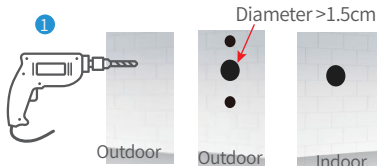
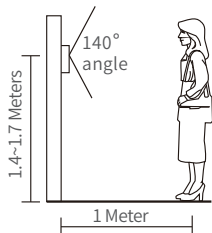

2. The rain cover is separated from the doorbell
3. The Cat5E/Cat6/Cat6A cable goes through the hole in the wall
4. Fix the rain cover with two screws
5. Plug the rain cover on the doorbell and fix the bottom screws

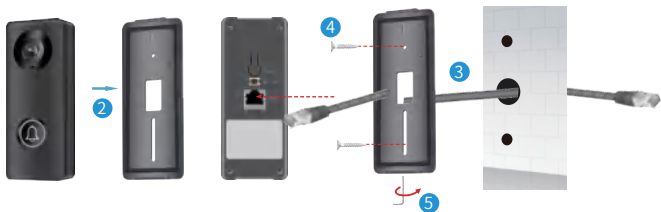

### Indoor monitor installation

1. Fix the hanging plate to the wall with two screws
2. Insert the MicroSD card to the slot of indoor monitor
3. Connect the port of cat5E cable to the indoor monitor
4. Connect the power supply for only 1 outdoor doorbell with 1 monitor.
5. Hang the indoor monitor to the hanging plate

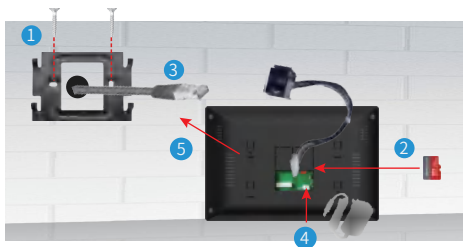

6. Connect the POE switch or connect routers via the POE injector.

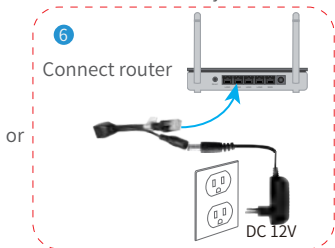
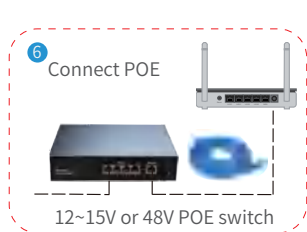

## 8 RFID Card Settings

The factory default includes 1 admin add card, 1 admin delete card, 5 user cards, ID card working frequency is 125KHz.

### 1 Set the admin card

1. Set to 'on' of ID card setting switch, both red and yellow lights are on
2. Then swipe a ID card, the card will be the admin add card, the blue light off.
3. Then swipe the second card, the card will be the admin delete card, the red light off
4. Set to '1' of ID card setting switch, then exit the setting mode.



### 2 Add user card

1. Swipe the admin add card
2. Then swipe a ID card, the card will be the user card
3. Continue to swipe the ID card to add the user card.
4. Swipe the admin add card

### 3 Delete User Card

1. Swipe the admin delete card
2. Then swipe a ID card, then delete the user card
3. Continue to swipe the card to delete the user card
4. Swipe the admin delete card

### 4 Delete all user cards

1. First swipe the admin delete card
2. Then swipe the admin add card
3. Then swipe the admin delete card again, so delete all user cards!

## 6 Unlock settings

Please check the specification of electric current for existing electronic lock, as the charger supplied is for a 12V power supply.

### 1. Wiring diagram of connect lock.

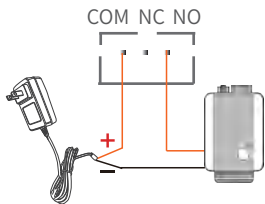

Connect the electric lock

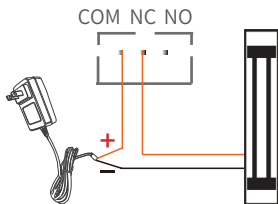

Connect the magnetic lock

### 2. Unlock controller wiring diagram (optional)

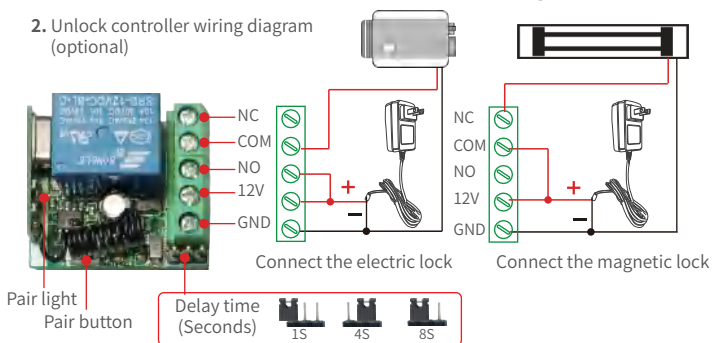

Connect the electric lock

Connect the magnetic lock

## 7 Device pairing

### 1 Pair unlock control with smart doorbell

1. Press the "pair" button of the unlock control, the pair light will flash once, then press the "Unlock" icon on the app, the pairing light will continue to flash.
2. Then press the "pair" button of the unlock control again, the light will stop flashing, then press the "Unlock" icon on the app again, the pairing light will flash several times. The pairing is successful.
3. Clear the pairing  
Press the "pair" button on the unlock control for longer than 3 seconds until the light on to off.

### 2 Pair remote control with unlock control

1. Press the "pair" button of the unlock control, the pair light will flash one time, then press the "unlock" button of the remote control, the pair light will flash continuously.
2. Then press the "pair" button of the unlock control again, the pair light stops flashing, then press the "unlock" button of the remote control again, the pair light will flash several times. The pairing is successful.

## 8 System connection

The Cat5e, Cat6 or above cable connected the doorbell and indoor monitor, 7-inch and 10.1-inch indoor monitor connections are the same.

### Way 1:

The indoor monitor connect the 12~15V power supply, One end of the Cat5e cable is connected to the outdoor doorbell, the other end is connected to the indoor monitor.

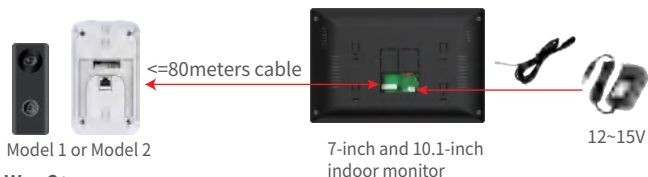

### Way 2:

Connect the router, need to connect the POE injector.

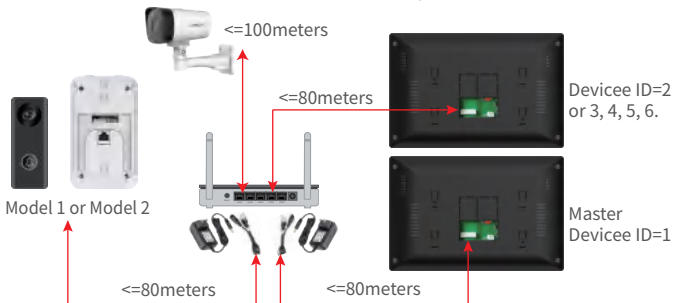

If need to connect more length or there are more connected devices, it is recommended to use a PoE Switch.

There are two types of outdoor doorbell that support 12V~15V and 48V, and indoor monitor support 12V~15V and 48V POE switch.

POE switches have 4, 5, 6, 8, 10, 12, 16 ports, can connect 12, 15V non-standard PoE Switch or 48V standard PoE Switch.



**POE power port (charged)**  
4 downlink POE 100M or 1000M power supply ports

**Transmission network (uncharged)**  
UPLINK connected to network device such as video recorders

Camera need to change to 1080P H.264 format ,  
IP address setting to 192.168.250.101~192.168.250.101, IP gateway: 192.168.250.1.  
so you need to connect to PC to set before installation.

### Way 3:

Connect to 48V PoE Switch, the system can connect up to 4 outdoor doorbells,  
4 cameras, 6 indoor monitors.

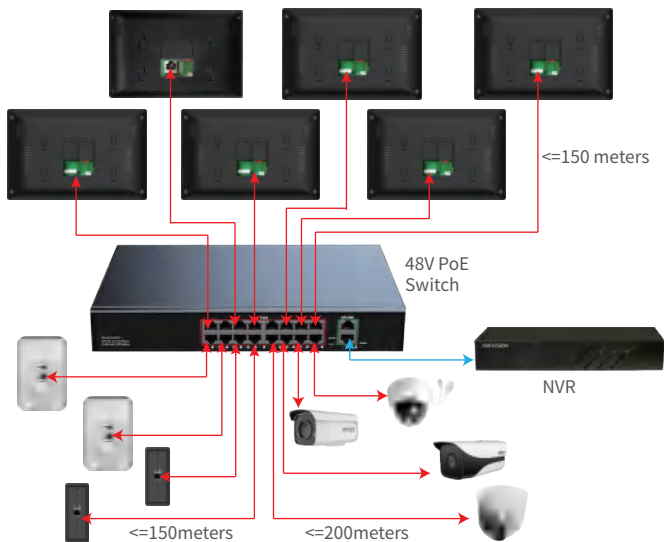

### Way 4:

Non-standard 12V or 15V PoE Switch

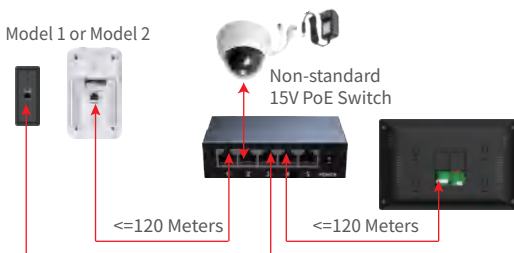





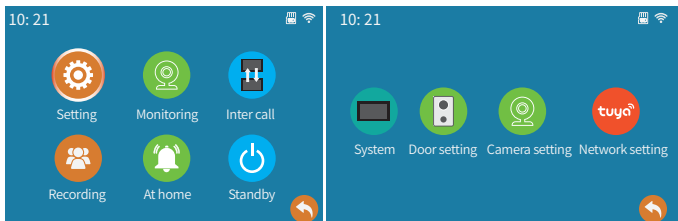

## 9 Indoor monitor operation introduction

### 1. Click 'Setting'



### 1.1 System settings

**Device ID:** Master indoor monitor setting connected to outdoor doorbell, Master indoor monitor ID setting to **1**. ID of slaves are setting sequentially **2, 3, 4, 5, 6**.

 System	Language	< English >
	Device_id	< 1 >
	Idle mode	< Time >
	Date format	< YY-MM-DD >
	Time	2021-01-01 00:45 
	Factory settings	Ok 
	Software update	Ok 
	Restart system	Ok 
	Formatting SD	Ok 
	SD remaining space	0.0G/0.0G
Software version	DBM-V1.3-220530	

### 1.2 Door settings

**Note:** Below setting by the main indoor monitor, the slave synchronizes the settings.

 Door setting	Door ID	< Door1 >	Door Number
	Unlock delay	< 2S >	Set the time of unlock delay.
	Message	< 30S >	Set the leave a message time.
	Motion detection	< Low >	Low/Medium/High/Off.
	MD preview switch	< On >	On/off.
	Ring select	< 1 >	Choose one of 10 ringtones.
	Ring volume	< 7 >	Volume level is 0~9.
	Ringback	< On >	On/Off

## 1.3 Camera settings

### A Connect Hikvision PoE camera

Tested Hikvision device that can be connected:

DS-IPC-B12HV3-IA, DS-IPC-T12HV3-IA, log on to Hikvision website, followed by Support-> Tools->Hitools->SADP from Hikvision's website. Connect the Hikvision camera and the computer to the same LAN.

The screenshot shows the SADP (Smart Audio Device Protocol) interface. At the top, it displays 'Total number of online devices: 2' with buttons for 'Unbind', 'Export', 'Refresh', and 'Filter'. Below this is a table of devices:

ID	Device Type	Status	IPv4 Address	IPv4 Gate...
001	DS-IPC-B12HV3-IA	Inactive	192.168.1.64	192.168.1.1

A red arrow points to the checkbox next to ID 001. Below the table, there are two main sections:

- Activate the Device:** Features a lock icon and the message 'The device is not activated.' Below this, a blue box states: 'You can modify the network parameters after the device activation.' There is an 'Activate Now' button, a 'New Password' field (with a strength indicator showing 'Weak'), and a 'Confirm Password' field. A red 'Activate' button is at the bottom.
- Modify Network Parameters:** Includes checkboxes for 'Enable DHCP' and 'Enable Hik-Connect'. The 'Device Serial No.' is 'DS-IPC-B12HV3-IA2022052'. The 'IP Address' is '192.168.250.164', 'Port' is '8000', 'Subnet Mask' is '255.255.255.0', and 'Gateway' is '192.168.250.1'. There is a 'Security Verification' section with an 'Administrator Password' field. A red 'Modify' button is at the bottom.

A 'Forgot Password' link is visible at the bottom right.

#### A1. Active the device

Select the inactive camera, then set a password and click <Activate>.

Note: This password is the login password of the IE interface.

#### A2. Set the IP Address and Gateway

Set the IP address to 192.168.250.101~192.168.250.240,

Set the Gateway to 192.168.250.1

This screenshot shows the SADP interface after the device has been activated and its network parameters modified. The table now shows two active devices:

ID	Device Type	Status	IPv4 Address	IPv4 Gateway	HTT...
001	DS-IPC-T12HV3-IA	Active	10.65.0.168	10.65.0.1	80
002	DS-IPC-B12HV3-IA	Active	192.168.250.164	192.168.250.1	80

A red circle highlights the IP address '192.168.250.164' in the second row.

Double click the IP address

A3. Set resolution: 1920\*1080P

A4. Set video encoding: H.264

The screenshot shows the Hikvision configuration interface. The 'Config' tab is active, and the 'Video/Audio' sub-tab is selected. The 'Resolution' dropdown is set to '1920\*1080P' and the 'Video encoding' dropdown is set to 'H.264'. Other settings include Stream type (Main stream (timed)), Video type (Composite stream), Code rate type (Fixed stream rate), Image Quality (Medium), Video frame rate (25 fps), Bit rate cap (4096 Kbps), Low stream rate (On), Coding complexity (Medium), and Frame rate (50). A red 'Save' button is located at the bottom center.

A5. Enable Onvif then click <Add> to Onvif user.

The screenshot shows the Hikvision configuration interface with the 'Onvif' sub-tab selected. The 'Enable onvif' checkbox is checked, and the 'Onvif version' is set to 18.12. Below this is a 'User list' table with columns for 'No', 'User Name', and 'User Type'. An 'Add' button is highlighted with a red arrow. An 'Add User' dialog box is open, showing the following fields: 'User Name' (admin), 'Password' (masked), 'Password confirm' (masked), and 'User type' (Administrator selected). A red 'Save' button is at the bottom left of the dialog. A 'Confirm' button is highlighted with a red arrow at the bottom right of the dialog.

A6. Adds user name and password.  
Note: When adding a camera, enter it and log in.

## B Connect Other brand network Camera

Network camera and the computer to the same LAN.



Total number of online devices: **1** Unbind Export Refresh Filter

<input checked="" type="checkbox"/>	ID	Device Type	Status	IPv4 Address	IPv4 Gateway
<input checked="" type="checkbox"/>	001	DS-2CD3T20D-I3	Active	192.168.250.156	192.168.250.1

**Modify Network Parameters**

Enable DHCP  
 Enable Hik-Connect

Device Serial No.: DS-2CD3T20D-I3773ad367

IP Address: 192.168.250.156

Port: 8000

Subnet Mask: 255.255.255.0

Gateway: 192.168.250.1

Secure Password: 123456

Administrator Password:

Modify Forgot Password

B3. Double click the IP address

**Login** English

Forgot Password

Login

B4. Login IE, No password or Password is 123456

**System** Encode

Compression: H.265X

Resolution: 1080P

Frame Rate(fps): 18

Bit Rate Type: VBR

Quality: Good

Bit Rate(Kb/S): 3124

- B1. Set the IP address to 192.168.250.101~192.168.250.240
- B2. Set the Gateway to 192.168.250.1

- B5. Set resolution: 1920\*1080 or 1080P
- B6. Set video encoding: H.264 or H.265X

## C. Connect Dahua POE Camera

Tested device models that can be connected: DH-IPC-HFW1230M series, DH-IPC-HDW1235C, DH-P30A1-A, DH-P20B1-A series.

Go to Dahua's website -> Support -> Tool -> Desktop Tools->ConfigTool, run after installation the ConfigTool.

C1. Select the uninitialized device and click <Initialize>.

**Configtool**

1 Device(s) found Search Setting

Initialize Batch Modify IP Import Export Manual Add Delete Search

<input checked="" type="checkbox"/>	NO.	Status	Type	Model	IP : Port	Operate
<input checked="" type="checkbox"/>	1	Uninitialized	IPC	DH-IPC-HDW1230...	192.168.1.108:37777	<span>Edit</span> <span>Details</span> <span>Web</span>

You have selected 1 device(s)  Uninitialized  Initialized IPv4 IPv6

C2. Click Initialize, set a password of at least 8 digits.

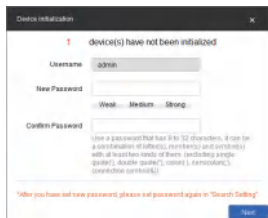
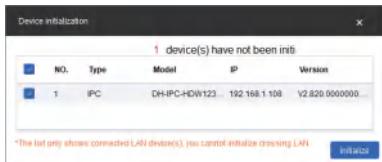

C3. Click <Search Setting>, **Note:** Enter the password you just set

C4. Set the IP address to 192.168.250.101~192.168.250.240

C5. Set the Gateway to 192.168.250.1

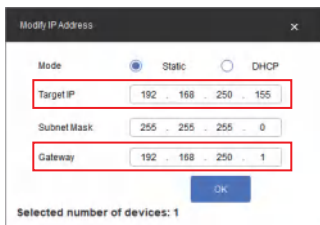
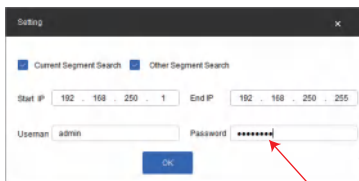

C6. Set resolution: 1920\*1080P

C7. Set video encoding: H.264

Configtool

1 Device(s) found

Search Setting

IPC 192.168.250.155-37777

Encode Image Profile Management

Channel: 1

Main Stream

Code Stream Type: Regular Compression: H.264H

Bit Rate Type: CBF (selected) VBR

Frame Rate: 25

Resolution: 1080P

Quality: 4

Bit Rate(Kb/S): 4095

Sub Stream

Code Stream Type: Regular Compression: H.264H

Bit Rate Type: CBF (selected) VBR

Frame Rate: 25

Resolution: D1

Audio: [checked]



Audio Encode: G.711A



Sampling Frequency: 8000

AudioVideo: [checked]

Audio Encode: G.711A

Apply to

1. Finish the setting of the camera , click Camera Settings -> Search  on the indoor monitor.
2. Select the camera added in the list → enter the username and password → Click  → login successful.  
Check the camera, the green dot shows that the device is connected.
3. Add multiple cameras in sequence.

 Camera Setting	Camera ID	< No_camera >	 Camera Setting	Camera ID	< No_camera >
	IP address			Username	admin
	New device found	Search 		Password	*****
	1.192.168.250.209	DH-IPC-HDW1235C		IP address	192.168.250.209
				Model Number	DH-IPC-HDW1235C

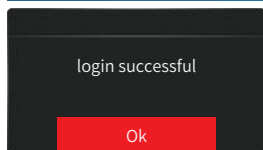

**Note:** Not Hikvision and Dahua camera, username is admin, password is 123456.

Username and password set by IE or ConfigTool if Hikvision and Dahua camera.

2. Click "Inter call", user can call other indoor monitor.



3. Record files

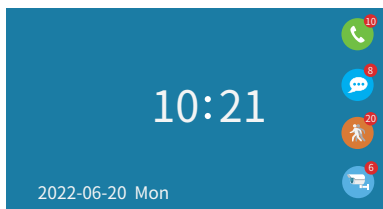

Note: The recording function needs to be inserted into the TF card.

1. Call record: For each call, there is a call record.
2. Leave a message: When no one is at home, turn on the leave home mode, and automatically turn on the message function.
3. Motion detection: After the motion detection is turned on, when someone comes to the doorbell, the video will be recorded.
4. Camera: Connect the camera, click the camera to monitor the files that take pictures and videos actively.

## 1.4 Network setting









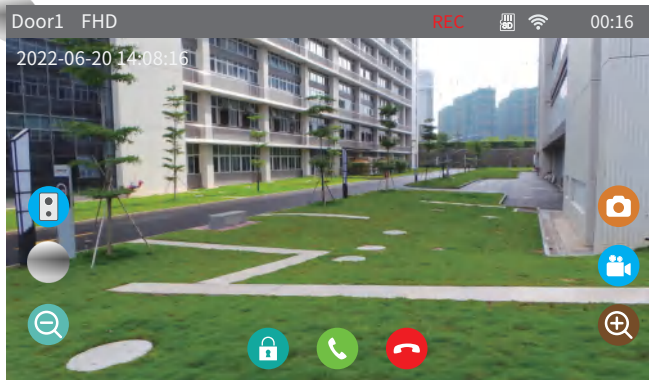

**Note:** Can only be set on the master indoor monitor.

The master indoor monitor is connected to 2.4G WiFi, include "EZ Mode" and "AP Mode", for specific operations, please refer to "10 Add Master indoor monitor to APP".

## 4. Monitor , all and answer

Click "Monitoring" button or after presses the "call" button of the outdoor doorbell.



-  Monitor next doorbell
-  Take a photo
-  Video
-  This icon will appear after visitor presses the "call" button of the outdoor doorbell. If user find that visitors are looking for another indoor monitor, User can transfer to another indoor monitor to talk with visitor.
-  Adjust the volume of doorbell and monitor
-  Zoom in
-  Zoom out
-  Unlock
-  Talk
-  Hang up
-  User is talking with the visitor.

## 5. Working modes

**Note:** The indoor monitor needs to insert the TF card and the message is enabled.

- 1. At home:** After the visitor presses the "call" button, the indoor monitor rings, Tuya APP will receive the call or receives the push, and if the call is not answered, outdoor doorbell will prompt to leave a message.
- 2. Not at home:** After the visitor presses the "call" button, the visitor will be prompted to leave a message, Tuya APP will receives the push.
- 3. Dormant:** When calling, neither the outdoor doorbell nor the indoor station have ringtones or prompts, the APP will receive the call.

## 10 App Download

1. Search "Tuya Smart" or "Smart life" from APP store or Google Play according to phone system.
2. Scan the QR code to download.



## 11 APP register & login

1. Please register when using APP for the first time.
2. After logging on the APP, please add devices after creating a family. At the bottom right corner of the APP homepage, click "Me" -> "Home Management" -> "Create a home", fill in the information and save it. The user who adds the device will become the family owner and can set the family owner or general members .
3. After the home owner adds the device, the home members will add the device automatically. After adding this doorbell, all home members have unlock function than shared accounts. User can add 20 administrators or home members.
4. The video doorbell is a device with a higher security level, the device must be removed from the original account before it can be bound to another account.

## 12 Add Master indoor monitor to APP

**Note:** only the master can connect to the Tuya Smart APP, the slave cannot be connect. Click "Settings"  to enter "Network Settings"  to enter the network setting.

Indoor monitor has two network pairing modes 1. EZ Mode 2. AP Mode

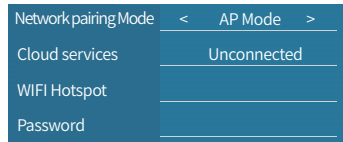
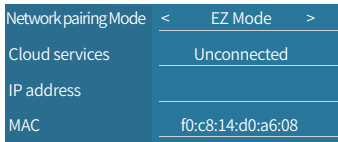

- 1 Click "+" on the top right of the homepage.
- 2 Select "Add Manually" -> "Security & Video Surveillance" -> "Smart Doorbell".

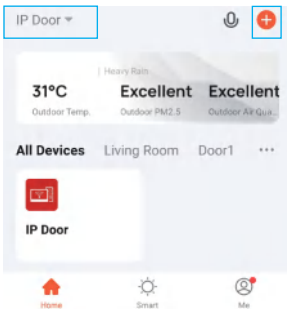

1

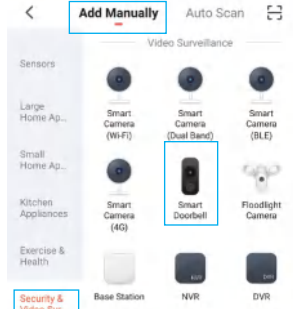

2

- 3 Select item 3 "EZ mode"
- 4 Confirm that the indoor monitor is in the network configuration mode, check it, and click "Next".

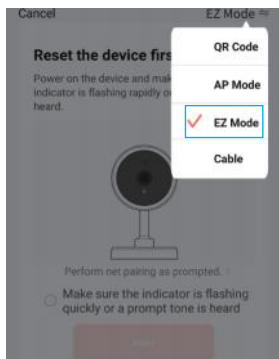

3

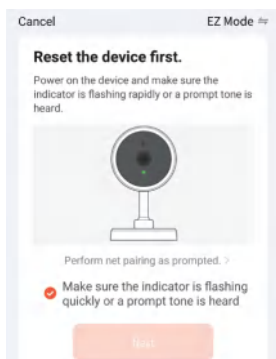

4

The indoor monitor only connect 2.4G WiFi, cannot connect 5G WiFi signal!

- 5 Select the 2.4GHz WiFi to be connected, enter the WiFi password then click "Next".
- 6 Enter the "Adding device..." then "Scan devices." -> "Register on Cloud." -> "Initialize the device.", Wait for about 1 minute.
- 7 It shows that the added successfully, user can modify the device name, and click "Done" to finish the adding the device.

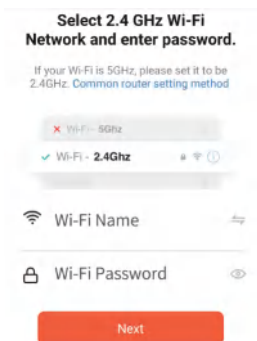

5



6

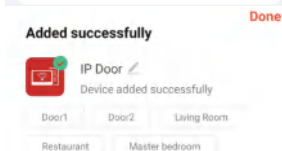

7

## 2. AP Mode

Select "AP Mode" then click the "return"  icon, the indoor monitor will restart system, and then return to the network setting interface, will display hotspot SmartLife-XXXXXX, the password is 12345678.

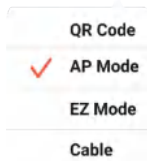
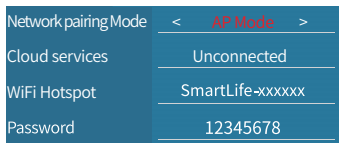

- 1 Click "+" on the top right of the homepage.
- 2 Select "Add Manually" -> "Security & Video Surveillance" -> "Smart Doorbell".
- 3 Select the second item "AP Mode"
- 4 Check this check box and click "Next".
- 5 Select 2.4GHz WiFi, enter the WiFi password, and click "Next".
- 6 Click the "Go to Connect" icon.
- 7 Connect to the SmartLife-XXXXXX hotspot, enter the password "12345678", Click the "Back" icon in the upper left corner to return to the APP.

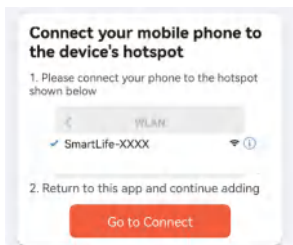

6

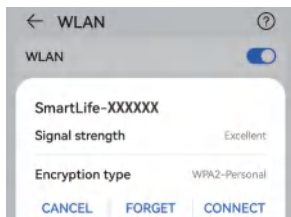

7

- 8 Enter the "Adding device..." then "Scan devices." -> "Register on Cloud" -> "Initialize the device". This process takes about 1 minute.
- 9 It shows that the added successfully, user can modify the device name, and click "Done" to finish the adding the device.

## 13 Motion detection and call push

1 After the visitor presses the call button, push notifications online.

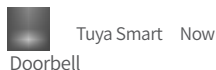

2 The mobile phone standby state is pushed notifications as follows.



### Motion detected

IP Door has detected movement

### You have a visitor

IP Door, someone is ringing the bell

Click the "Settings" icon in the upper right corner to enter the notifications push settings

- 2.1 Click the **"Motion detected"** to enter the alarm message
- 2.2 Click the **"You have a visitor"** to enter the living video.

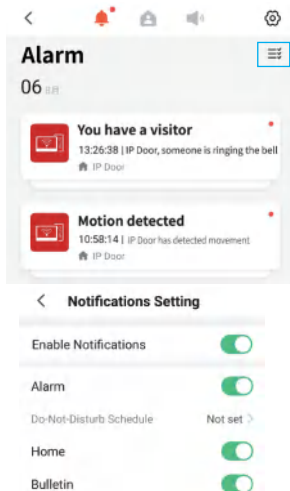

## 14 Help and service

Users can click "Me" of homepage on the APP to enter "service and help".

- 1 "Home Management" can create a home or join a home and set permissions.
- 2 "Message Center" can view alarm information.
- 3 If user are not familiar with the app or device, pls check "Help and Feedback".

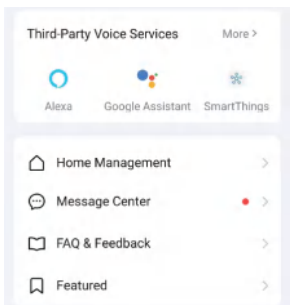

## 15 Live video

Click on the device on the homepage of APP to enter the living screen, user can take photos, talk, video, unlock, playback(stored in the MicroSD Card), and view albums.

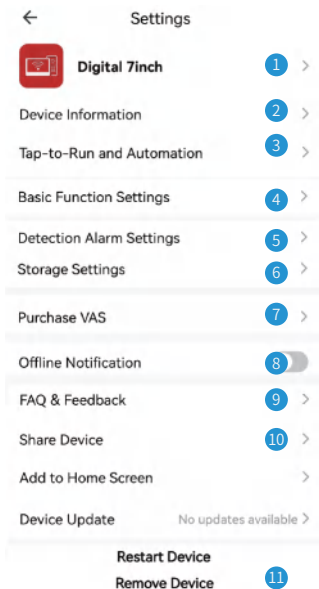
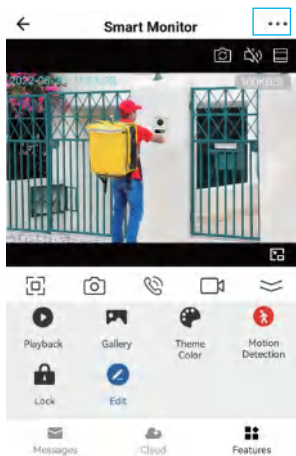

Click the button in the upper right corner to enter the setting interface.

lock: Unlock and save all records.

Message: Take photos and videos during incoming calls or motion detection.

Cloud: The photos and videos stored in the cloud server during incoming calls or motion detection, do not worry about losing the doorbell.

- 1 Modify icon, name, location of device.
- 2 View IP address, ID, time zone.
- 3 Configure the device automation.
- 4 1 Turn on/off the light of the doorbell button 2 The screen horizontal mirroring.
- 5 Motion detection on/off, set the alarm sensitivity and the alarm time period.
- 6 Check the capacity of the memory card, and format the memory card.
- 8 The device will push the alarm information list to the APP after 30 minutes
- 9 Please check the common problems carefully.
- 10 Enter the mobile phone number or email address of the user you want to share, click "Finish", the shared user cannot unlock.
- 11 After removed the device, the device will not be displayed on the device list.