

推奨基板レイアウト寸法  
RECOMMENDED MOUNTING  
P.C. BOARD PATTERN LAYOUT DIM.

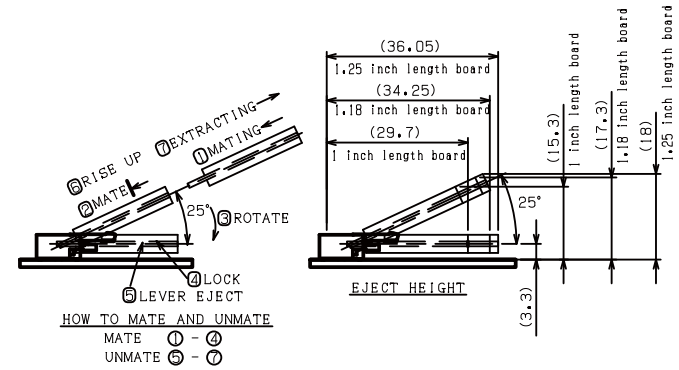

RoHS Compliant

TOLERANCES ARE

**MORETHANALL**  
PCB CONNECTORS  
Cable ASSEMBLIES

DRAWING BY CY

X, ±  
.X ± 0.20

CHECKED BY GENIUS

.XX ±  
.XXX ±  
ANG ± 3°

UNIT / mm

SCALE 1 : 1

DATE

SIZE A4

PJECTION

ORDER INFORMATION

SDM6-W52V15-72A3-LF

SERIES

LEADFREE

204 WAY

1.5V  
HIGH 5.2mm  
90°SMT

煜倫股份有限公司

www.morethanall.com

DESCRIPTION: FOR 204PIN DDR S.O DIMM(DDR3)

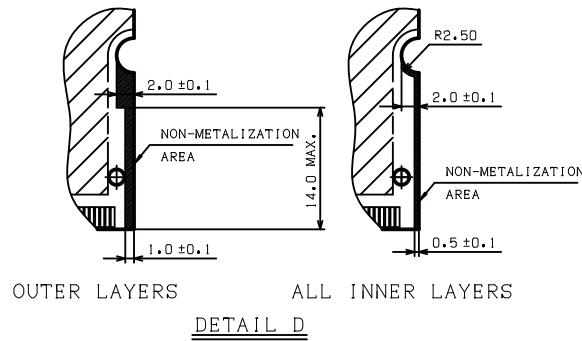
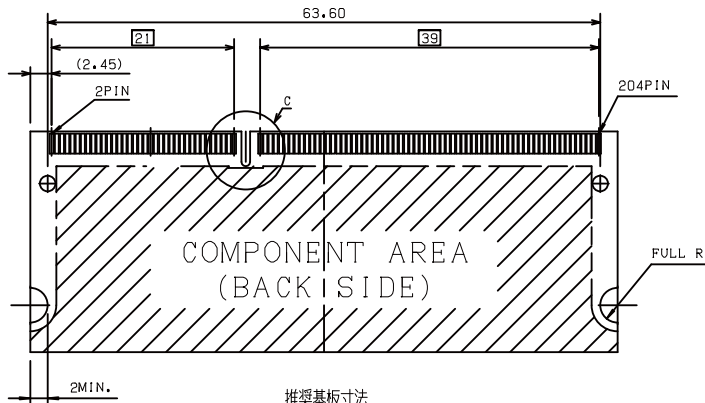
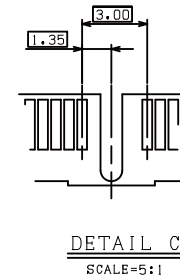
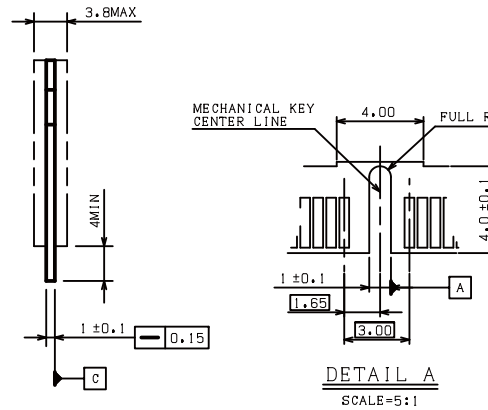
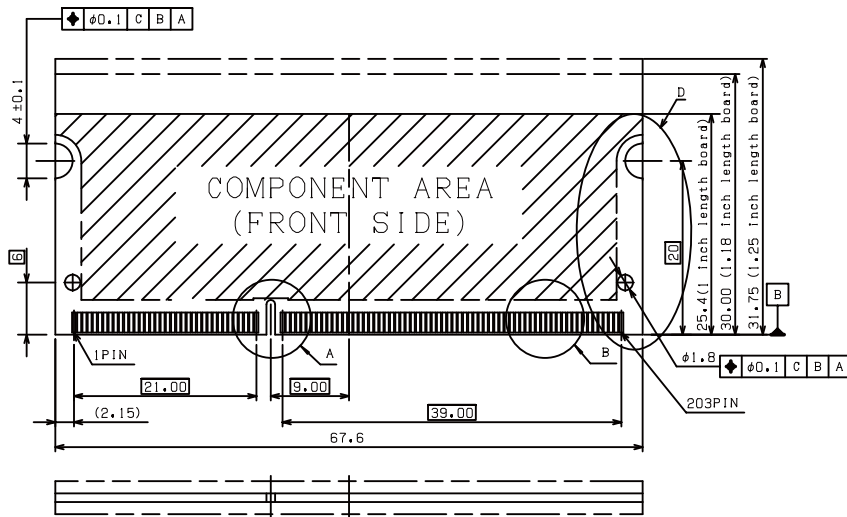

推奨基板寸法  
RECOMMENDED MATING  
P.C. BOARD DIM.

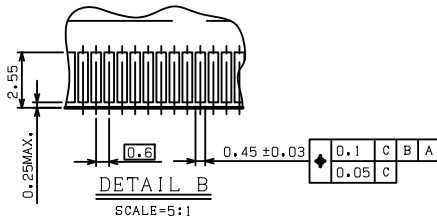

注記: (SHEET 3 に適用)

NOTES: (APPLIED TO SHEET 3)

1. 一般公差±0.15

TOLERANCES ON ALL DIMENSION ±0.15 UNLESS OTHERWISE SPECIFIED.

2. 基板厚寸法は、メッキ厚を含む。

P.C. BOARD THICKNESS APPLIES ACROSS TABS AND INCLUDES PLATING AND/OR METALIZATION.

3. パット部の仕上げ: ニッケル下地メッキ 0.002MIN. 厚の上に、金メッキ 0.000756MIN. 厚を施す。

FINISH OF PAD: GOLD PLATING 0.00076MIN. OVER NI PLATING 0.002MIN.

RoHS Compliant

TOLERANCES ARE

**MORETHANALL**  
PCB CONNECTORS  
Cable ASSEMBLIES

DRAWING BY CY

X, ±

CHECKED BY GENIUS

.X ± 0.20

UNIT / mm

SCALE 1:1

.XX ±

DATE

.XXX ±

ANG ± 3°

SIZE A4

PJECTION



ORDER INFORMATION

SDM6-W52V15-72A3-LF

SERIES

LEADFREE

1.5V

HIGH 5.2mm

90°SMT

204 WAY

煜倫股份有限公司

www.morethanall.com

DESCRIPTION: FOR 204PIN DDR S.O DIMM(DDR3)

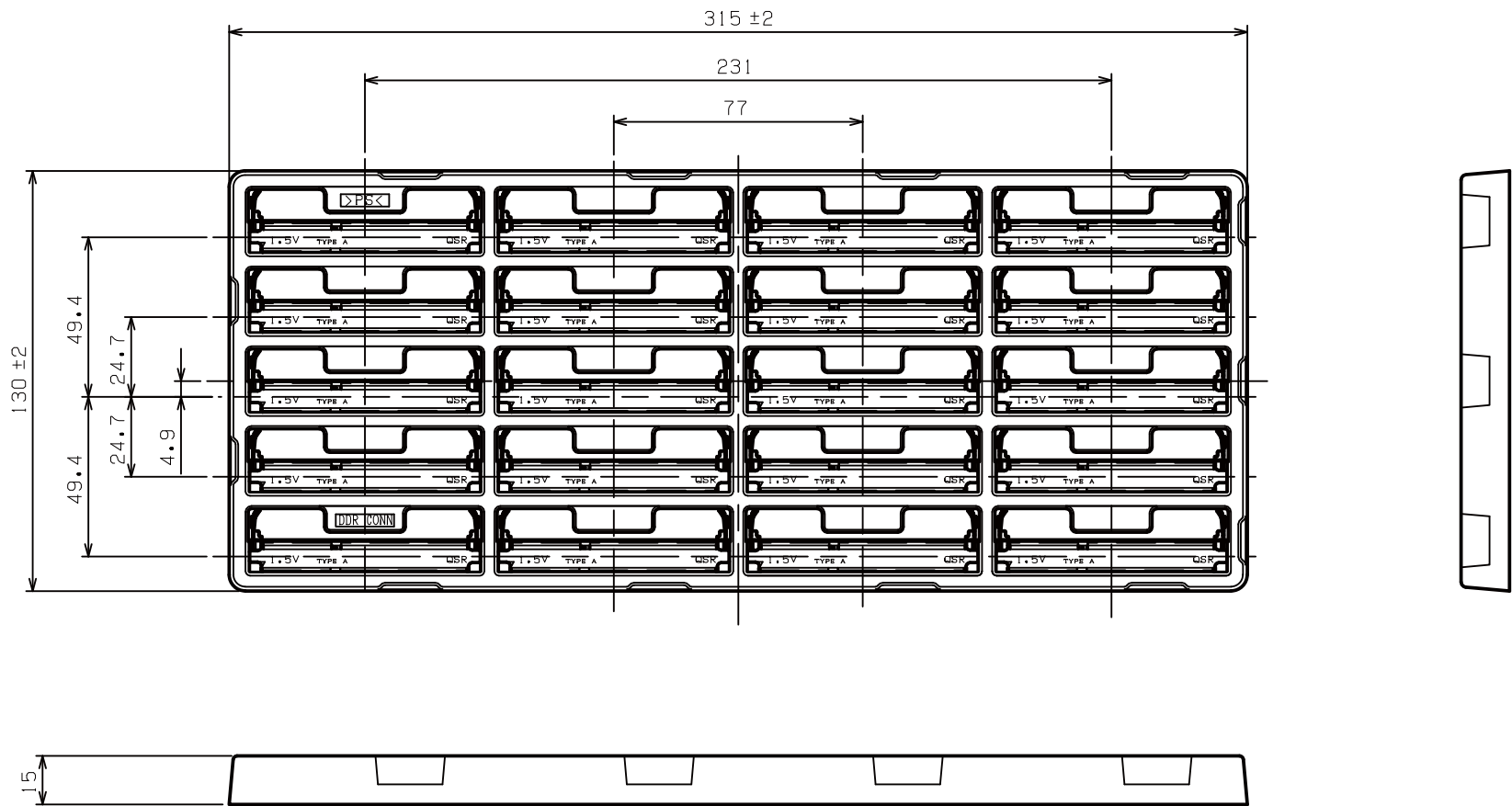

® SOFT TRAY PACKAGING

RoHS Compliant

TOLERANCES ARE

**MORETHANALL**  
PCB CONNECTORS  
Cable ASSEMBLIES

DRAWING BY CY

CHECKED BY GENIUS

UNIT / mm

SCALE 1:1

DATE

SIZE A4

PJECTION

X, ±  
.X ± 0.20  
.XX ±  
.XXX ±  
ANG ± 3°



ORDER INFORMATION

SDM6-W52V15-72A3-LF

SERIES

LEADFREE

204 WAY

1.5V  
HIGH 5.2mm  
90°SMT

煜倫股份有限公司

www.morethanall.com

DESCRIPTION: FOR 204PIN DDR S.O DIMM(DDR3)